

# iberalc

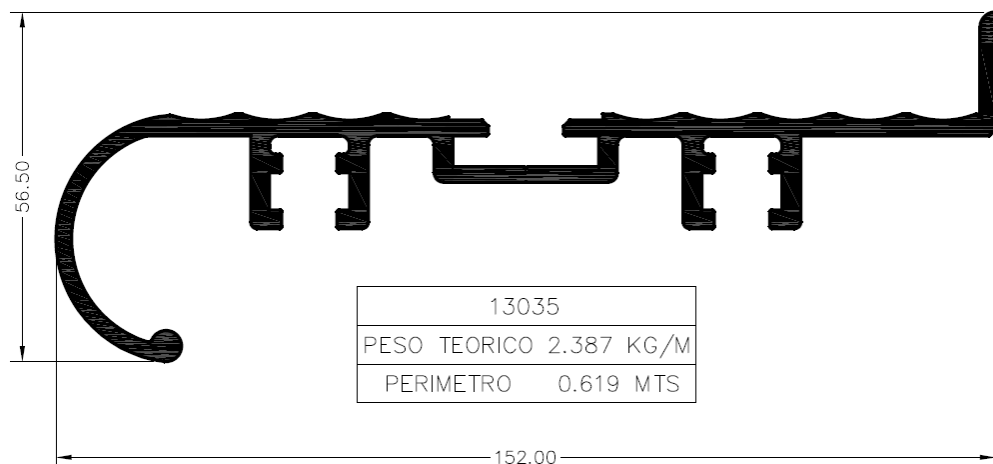

Iberalc, S.L. P.I. El Sequero Nº 177 – Arrúbal – La Rioja – España – Tlf 941205100 Fax 941222400  
[info@iberalc.com](mailto:info@iberalc.com) – [www.iberalc.com](http://www.iberalc.com)

## ESCALERAS

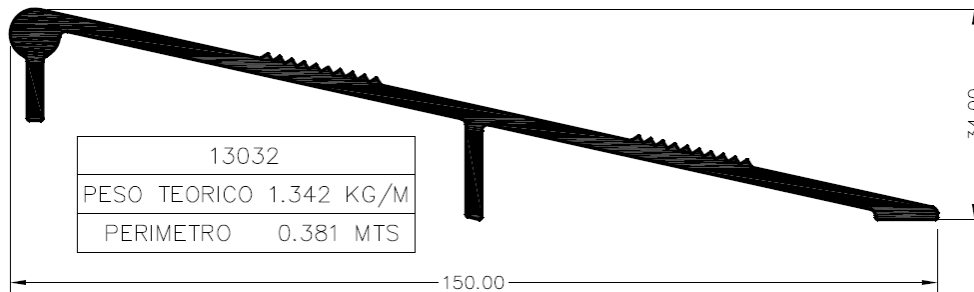
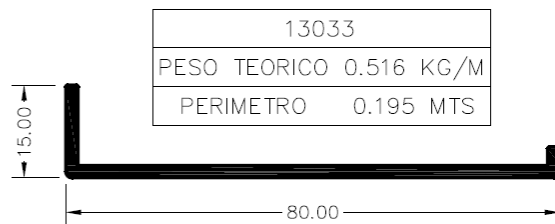
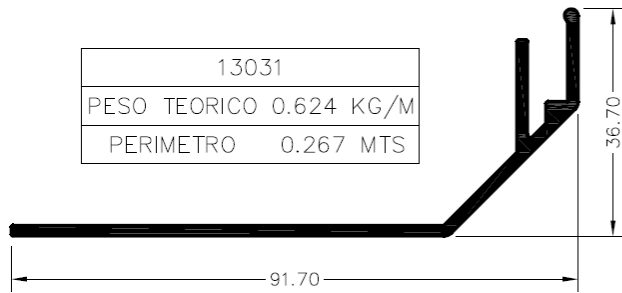



## ESCALERAS

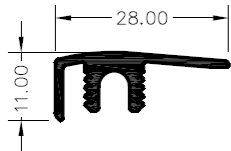

13150
PESO TEORICO 0.233 KG/M
PERIMETRO 0.110 MTS

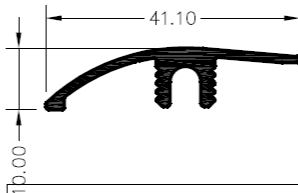

13151
PESO TEORICO 0.262 KG/M
PERIMETRO 0.125 MTS

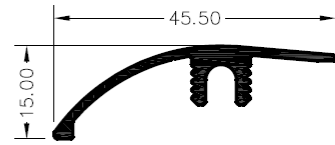

13152
PESO TEORICO 0.286 KG/M
PERIMETRO 0.139 MTS

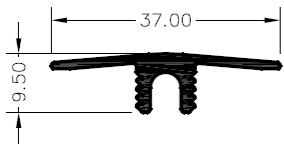

13153
PESO TEORICO 0.234 KG/M
PERIMETRO 0.111 MTS

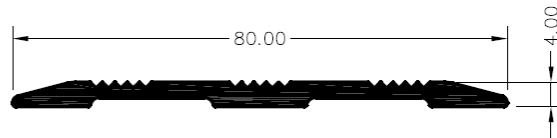

13164
PESO TEORICO 0.602 KG/M
PERIMETRO 0.178 MTS

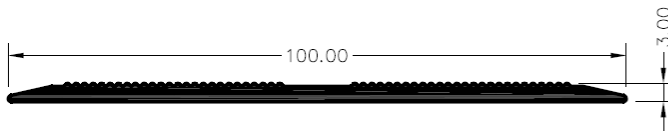

13165
PESO TEORICO 0.694 KG/M
PERIMETRO 0.221 MTS

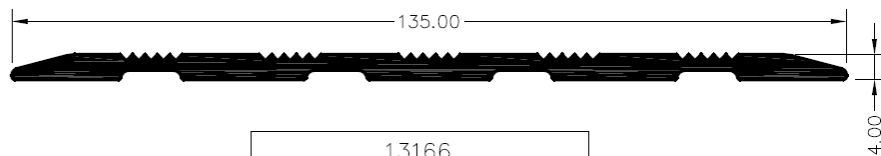

13166
PESO TEORICO 1.174 KG/M
PERIMETRO 0.300 MTS

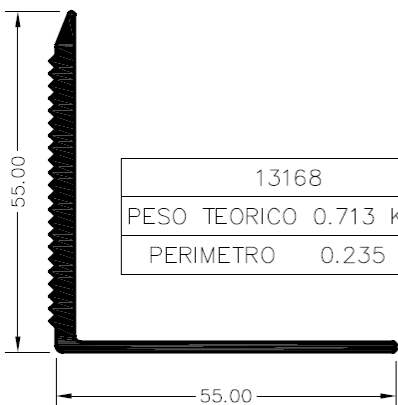

13168
PESO TEORICO 0.713 KG/M
PERIMETRO 0.235 MTS

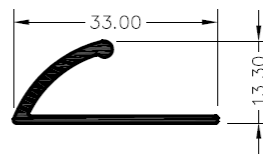

13167
PESO TEORICO 0.203 KG/M
PERIMETRO 0.106 MTS



## ESCALERAS

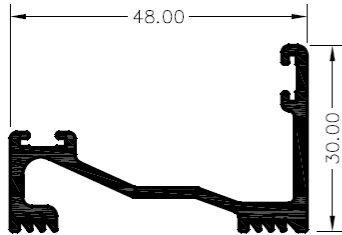

13169
PESO TEORICO 0.583 KG/M
PERIMETRO 0.239 MTS

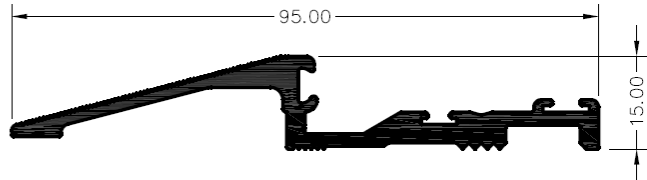

13170
PESO TEORICO 0.891 KG/M
PERIMETRO 0.283 MTS

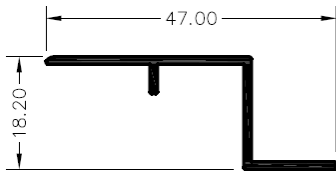

13171
PESO TEORICO 0.219 KG/M
PERIMETRO 0.137 MTS

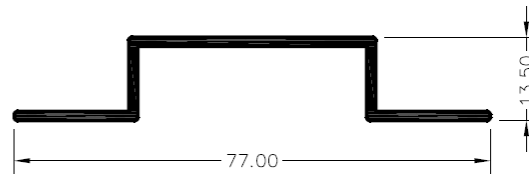

13172
PESO TEORICO 0.408 KG/M
PERIMETRO 0.203 MTS

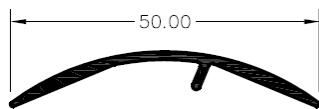

13173
PESO TEORICO 0.224 KG/M
PERIMETRO 0.115 MTS

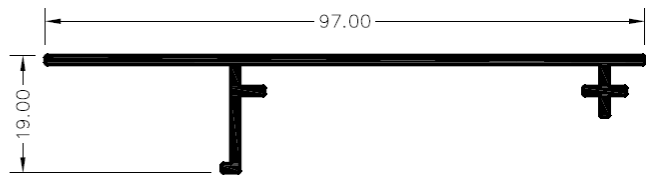

13174
PESO TEORICO 0.542 KG/M
PERIMETRO 0.269 MTS

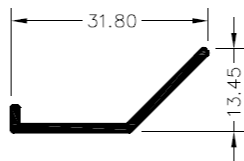

13175
PESO TEORICO 0.129 KG/M
PERIMETRO 0.081 MTS



## ESCALERAS

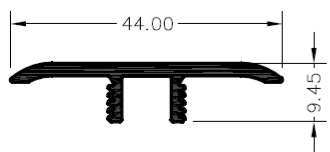

13176
PESO TEORICO 0.302 KG/M
PERIMETRO 0.132 MTS

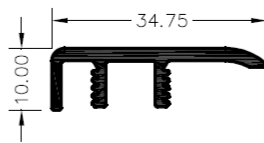

13177
PESO TEORICO 0.286 KG/M
PERIMETRO 0.129 MTS

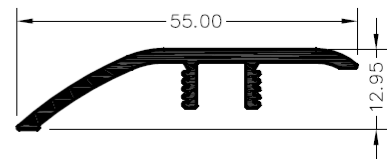

13181
PESO TEORICO 0.379 KG/M
PERIMETRO 0.160 MTS

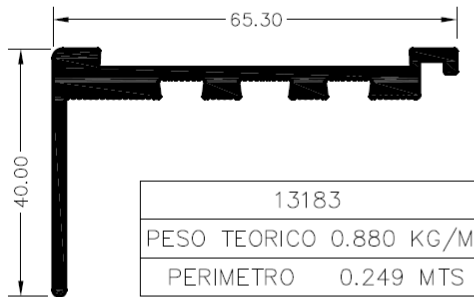

13183
PESO TEORICO 0.880 KG/M
PERIMETRO 0.249 MTS



13184
PESO TEORICO 0.859 KG/M
PERIMETRO 0.249 MTS

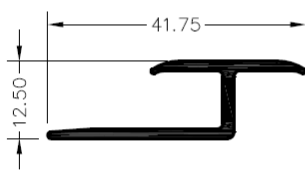

13185
PESO TEORICO 0.255 KG/M
PERIMETRO 0.128 MTS

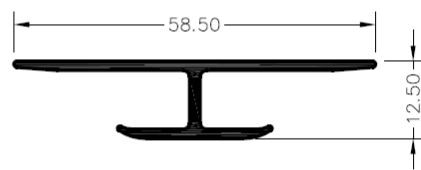

13186
PESO TEORICO 0.366 KG/M
PERIMETRO 0.184 MTS

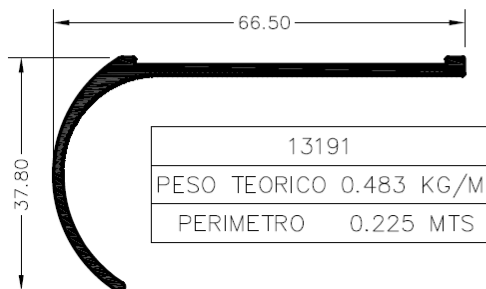

13191
PESO TEORICO 0.483 KG/M
PERIMETRO 0.225 MTS



13192
PESO TEORICO 0.914 KG/M
PERIMETRO 0.259 MTS



## ESCALERAS

