

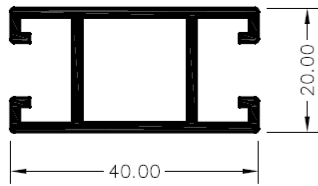

PERFILES EN H

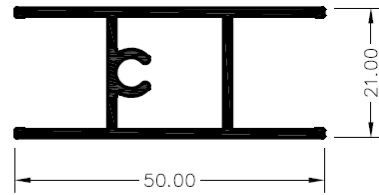

508	
PESO TEORICO	0.517 KG/M
PERIMETRO	0.273 MTS



3420	
PESO TEORICO	0.526 KG/M
PERIMETRO	0.295 MTS

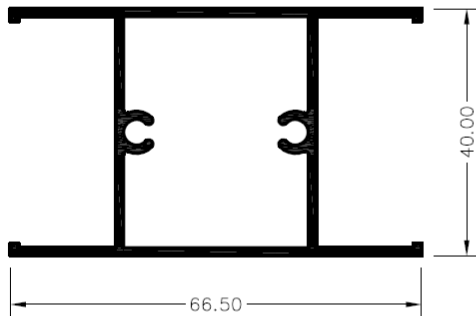

3653	
PESO TEORICO	0.815 KG/M
PERIMETRO	0.456 MTS

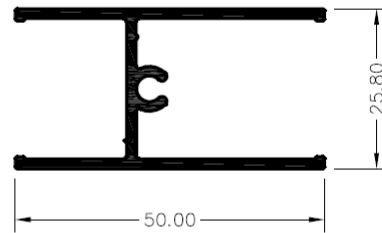

5365	
PESO TEORICO	0.550 KG/M
PERIMETRO	0.268 MTS

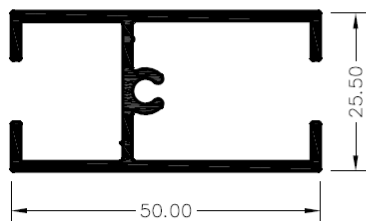

5366	
PESO TEORICO	0.647 KG/M
PERIMETRO	0.316 MTS

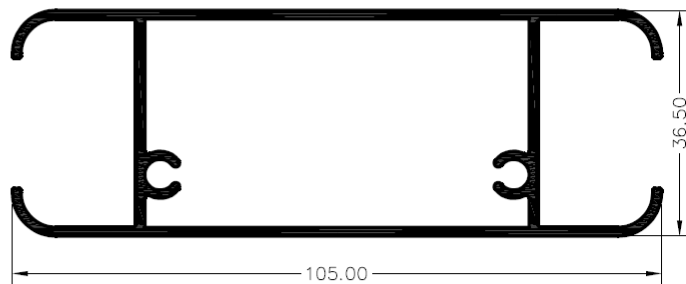

5417	
PESO TEORICO	1.195 KG/M
PERIMETRO	0.625 MTS



PERFILES EN H

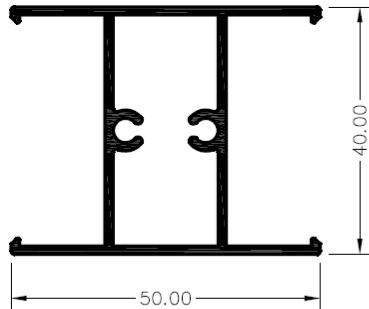

6332	
PESO TEORICO	0.701 KG/M
PERIMETRO	0.391 MTS

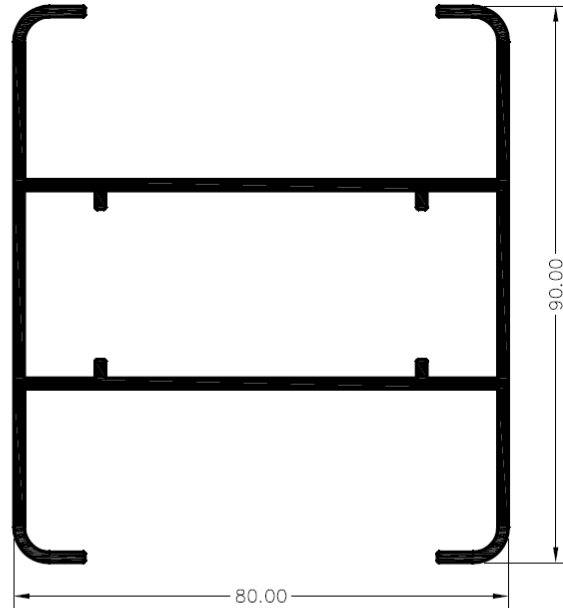

6781	
PESO TEORICO	1.725 KG/M
PERIMETRO	0.750 MTS

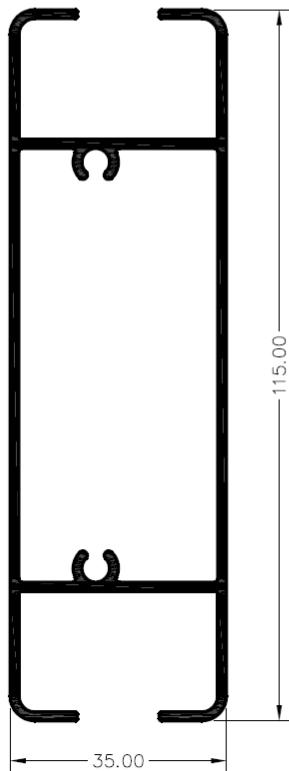

6883	
PESO TEORICO	1.320 KG/M
PERIMETRO	0.687 MTS

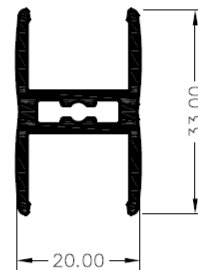

7053	
PESO TEORICO	0.440 KG/M
PERIMETRO	0.194 MTS



PERFILES EN H

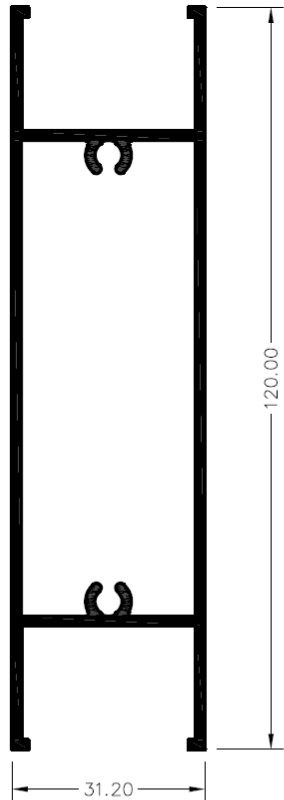

8011
PESO TEORICO 1.315 KG/M
PERIMETRO 0.642 MTS

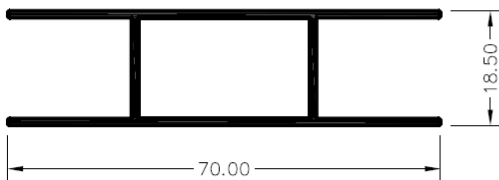

8066
PESO TEORICO 0.512 KG/M
PERIMETRO 0.344 MTS

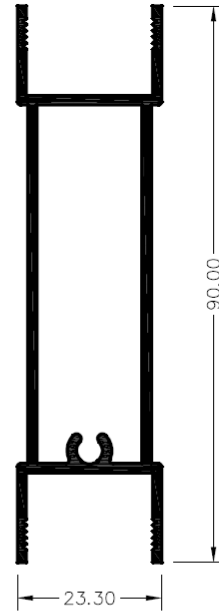

8039
PESO TEORICO 0.905 KG/M
PERIMETRO 0.467 MTS

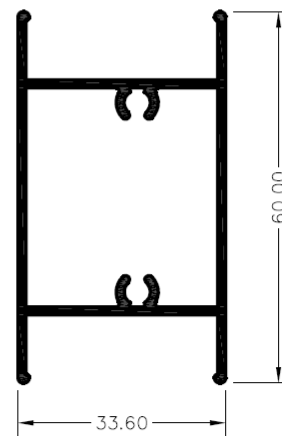

8079
PESO TEORICO 0.721 KG/M
PERIMETRO 0.404 MTS



PERFILES EN H

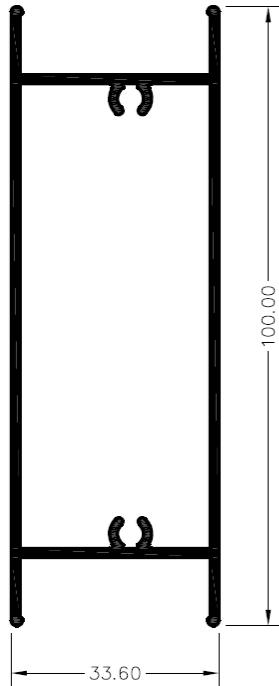

8080
PESO TEORICO 1.070 KG/M
PERIMETRO 0.562 MTS

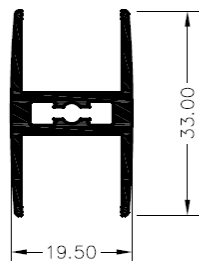

8736
PESO TEORICO 0.402 KG/M
PERIMETRO 0.195 MTS

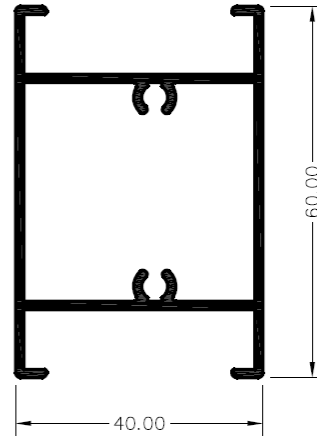

8081
PESO TEORICO 0.811 KG/M
PERIMETRO 0.455 MTS

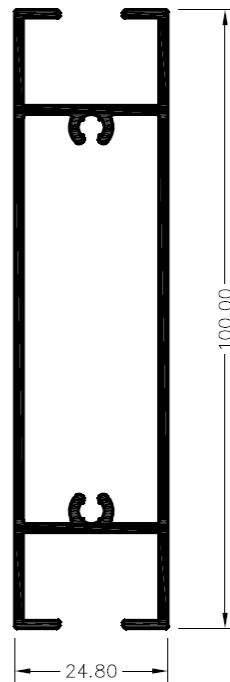

8125
PESO TEORICO 1.088 KG/M
PERIMETRO 0.570 MTS



PERFILES EN H

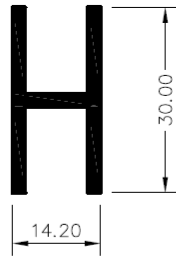

9105
PESO TEORICO 0.379 KG/M
PERIMETRO 0.144 MTS

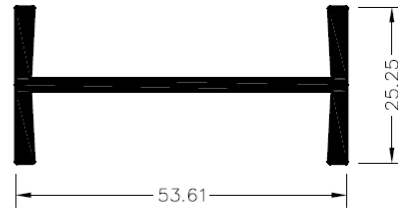

10041
PESO TEORICO 0.607 KG/M
PERIMETRO 0.206 MTS

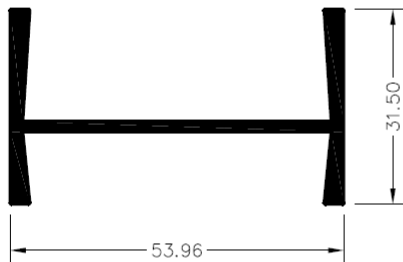

10042
PESO TEORICO 0.663 KG/M
PERIMETRO 0.235 MTS

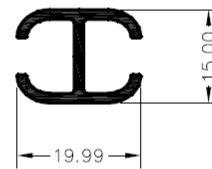

10042
PESO TEORICO 0.231 KG/M
PERIMETRO 0.115 MTS

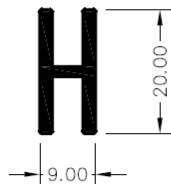

10590
PESO TEORICO 0.236 KG/M
PERIMETRO 0.094 MTS

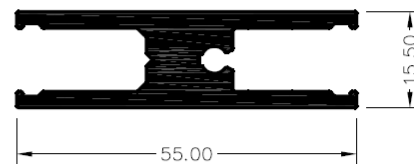

10687
PESO TEORICO 1.091 KG/M
PERIMETRO 0.236 MTS



PERFILES EN H

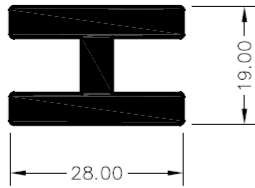

10750
PESO TEORICO 0.876 KG/M
PERIMETRO 0.138 MTS

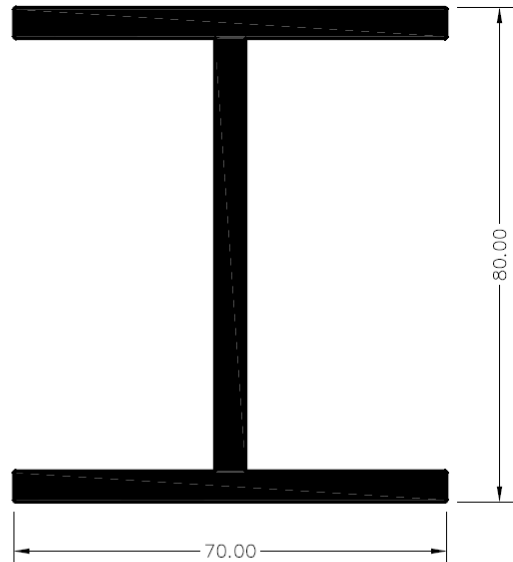

10911
PESO TEORICO 2.835 KG/M
PERIMETRO 0.429 MTS

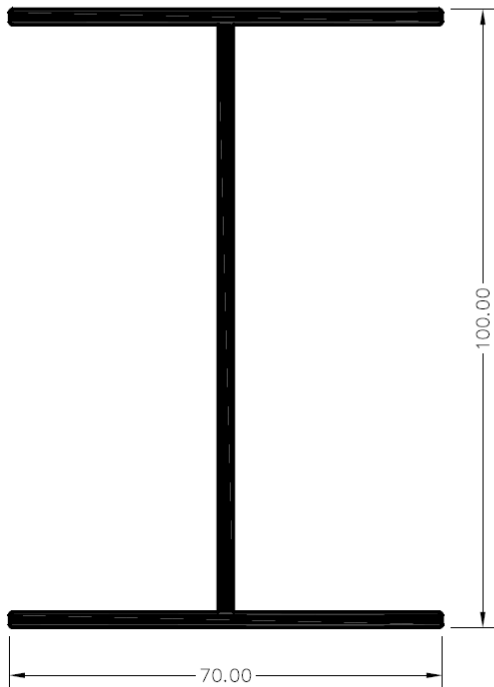

10950
PESO TEORICO 1.585 KG/M
PERIMETRO 0.473 MTS

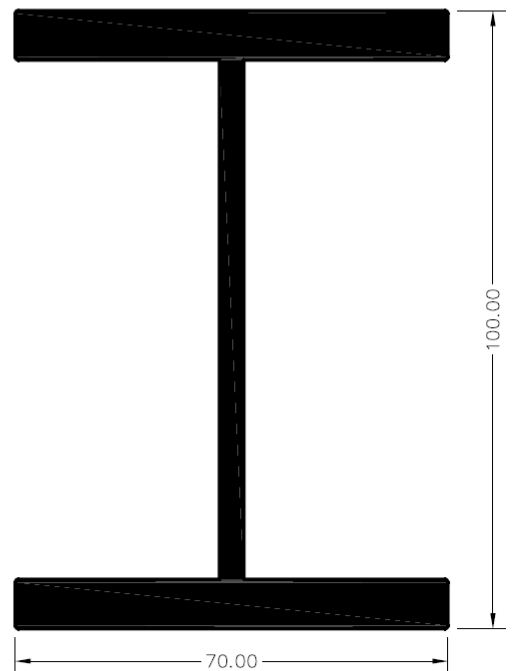

10951
PESO TEORICO 3.930 KG/M
PERIMETRO 0.470 MTS



PERFILES EN H

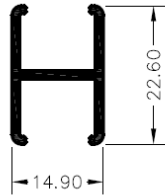

11099	
PESO TEORICO	0.195 KG/M
PERIMETRO	0.121 MTS

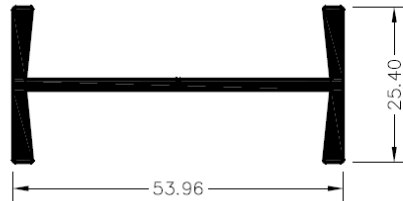

13000	
PESO TEORICO	0.593 KG/M
PERIMETRO	0.210 MTS

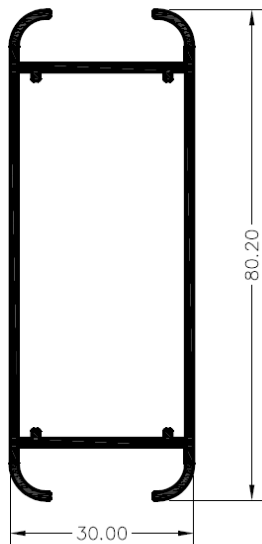

16063	
PESO TEORICO	0.817 KG/M
PERIMETRO	0.464 MTS

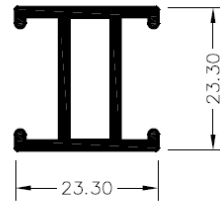

16137	
PESO TEORICO	0.380 KG/M
PERIMETRO	0.186 MTS

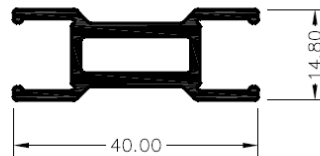

17106	
PESO TEORICO	0.500 KG/M
PERIMETRO	0.203 MTS



PERFILES EN H

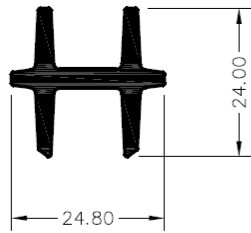

17137	
PESO TEORICO	0.470 KG/M
PERIMETRO	0.128 MTS

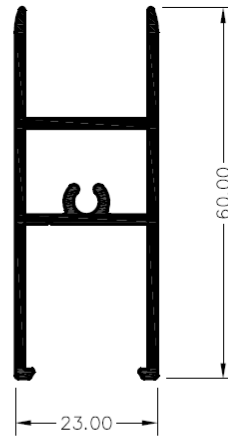

17162	
PESO TEORICO	0.695 KG/M
PERIMETRO	0.340 MTS

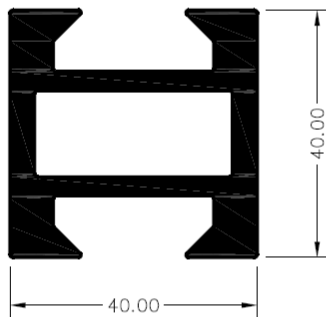

24000	
PESO TEORICO	1.840 KG/M
PERIMETRO	0.314 MTS