

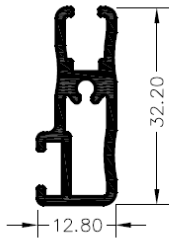

## LIBRE DISPOSICION

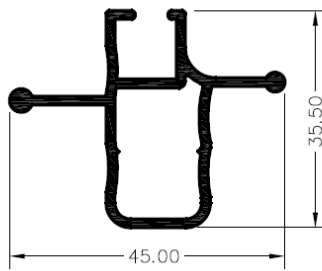

|                         |
|-------------------------|
| 4450                    |
| PESO TEORICO 0.359 KG/M |
| PERIMETRO 0.181 MTS     |



|                         |
|-------------------------|
| 4451                    |
| PESO TEORICO 0.521 KG/M |
| PERIMETRO 0.261 MTS     |

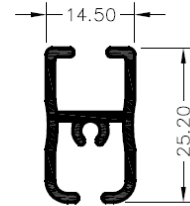

|                         |
|-------------------------|
| 4452                    |
| PESO TEORICO 0.305 KG/M |
| PERIMETRO 0.160 MTS     |

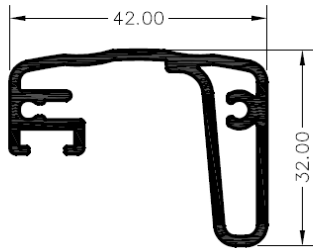

|                         |
|-------------------------|
| 4453                    |
| PESO TEORICO 0.643 KG/M |
| PERIMETRO 0.300 MTS     |

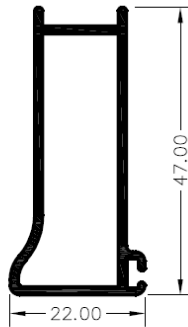

|                         |
|-------------------------|
| 4454                    |
| PESO TEORICO 0.454 KG/M |
| PERIMETRO 0.261 MTS     |

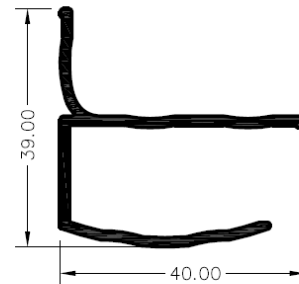

|                         |
|-------------------------|
| 4455                    |
| PESO TEORICO 0.446 KG/M |
| PERIMETRO 0.219 MTS     |

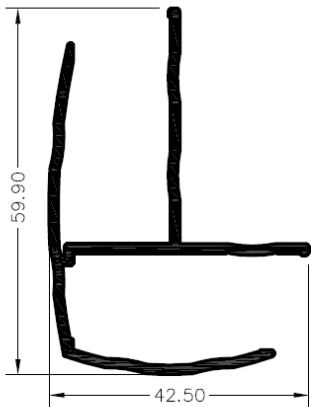

|                         |
|-------------------------|
| 4456                    |
| PESO TEORICO 0.675 KG/M |
| PERIMETRO 0.335 MTS     |

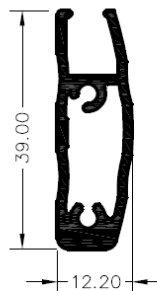

|                         |
|-------------------------|
| 4457                    |
| PESO TEORICO 0.446 KG/M |
| PERIMETRO 0.200 MTS     |

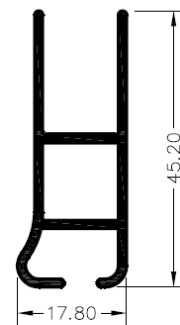

|                         |
|-------------------------|
| 4458                    |
| PESO TEORICO 0.429 KG/M |
| PERIMETRO 0.244 MTS     |

# iberalc



Iberalc, S.L. P.I. El Sequero Nº 177 – Arrúbal – La Rioja – España – Tlf 941205100 Fax 941222400  
[info@iberalc.com](mailto:info@iberalc.com) – [www.iberalc.com](http://www.iberalc.com)

## LIBRE DISPOSICION

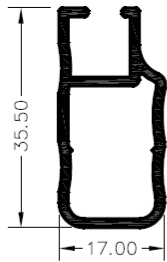

|                         |
|-------------------------|
| 4459                    |
| PESO TEORICO 0.389 KG/M |
| PERIMETRO 0.202 MTS     |

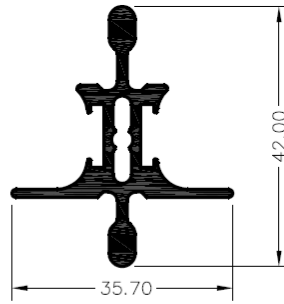

|                         |
|-------------------------|
| 4460                    |
| PESO TEORICO 0.594 KG/M |
| PERIMETRO 0.214 MTS     |



## LIBRE DISPOSICION

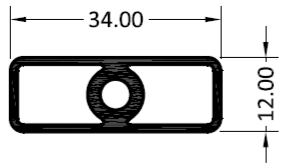

|                         |
|-------------------------|
| 1710                    |
| PESO TEORICO 0.383 KG/M |
| PERIMETRO 0.200 MTS     |

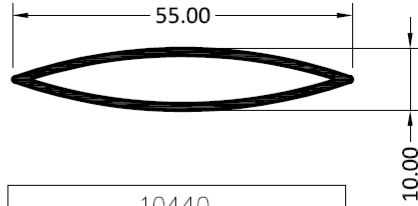

|                         |
|-------------------------|
| 10440                   |
| PESO TEORICO 0.321 KG/M |
| PERIMETRO 0.213 MTS     |

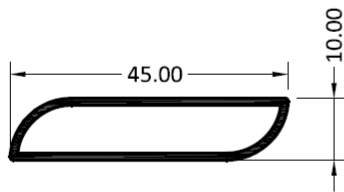

|                         |
|-------------------------|
| 850                     |
| PESO TEORICO 0.289 KG/M |
| PERIMETRO 0.194 MTS     |

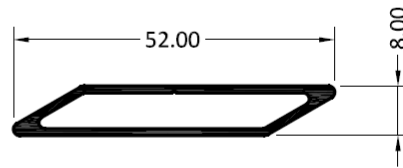

|                         |
|-------------------------|
| 8092                    |
| PESO TEORICO 0.328 KG/M |
| PERIMETRO 0.202 MTS     |

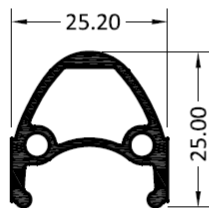

|                         |
|-------------------------|
| 10093                   |
| PESO TEORICO 0.374 KG/M |
| PERIMETRO 0.182 MTS     |

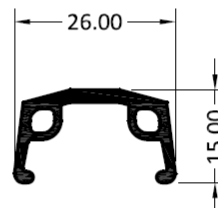

|                         |
|-------------------------|
| 10094                   |
| PESO TEORICO 0.270 KG/M |
| PERIMETRO 0.126 MTS     |

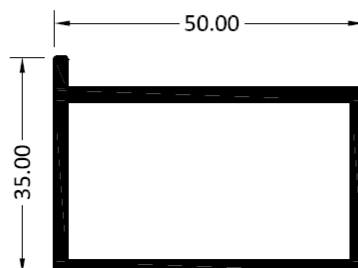

|                         |
|-------------------------|
| 10351                   |
| PESO TEORICO 0.848 KG/M |
| PERIMETRO 0.313 MTS     |



## LIBRE DISPOSICION

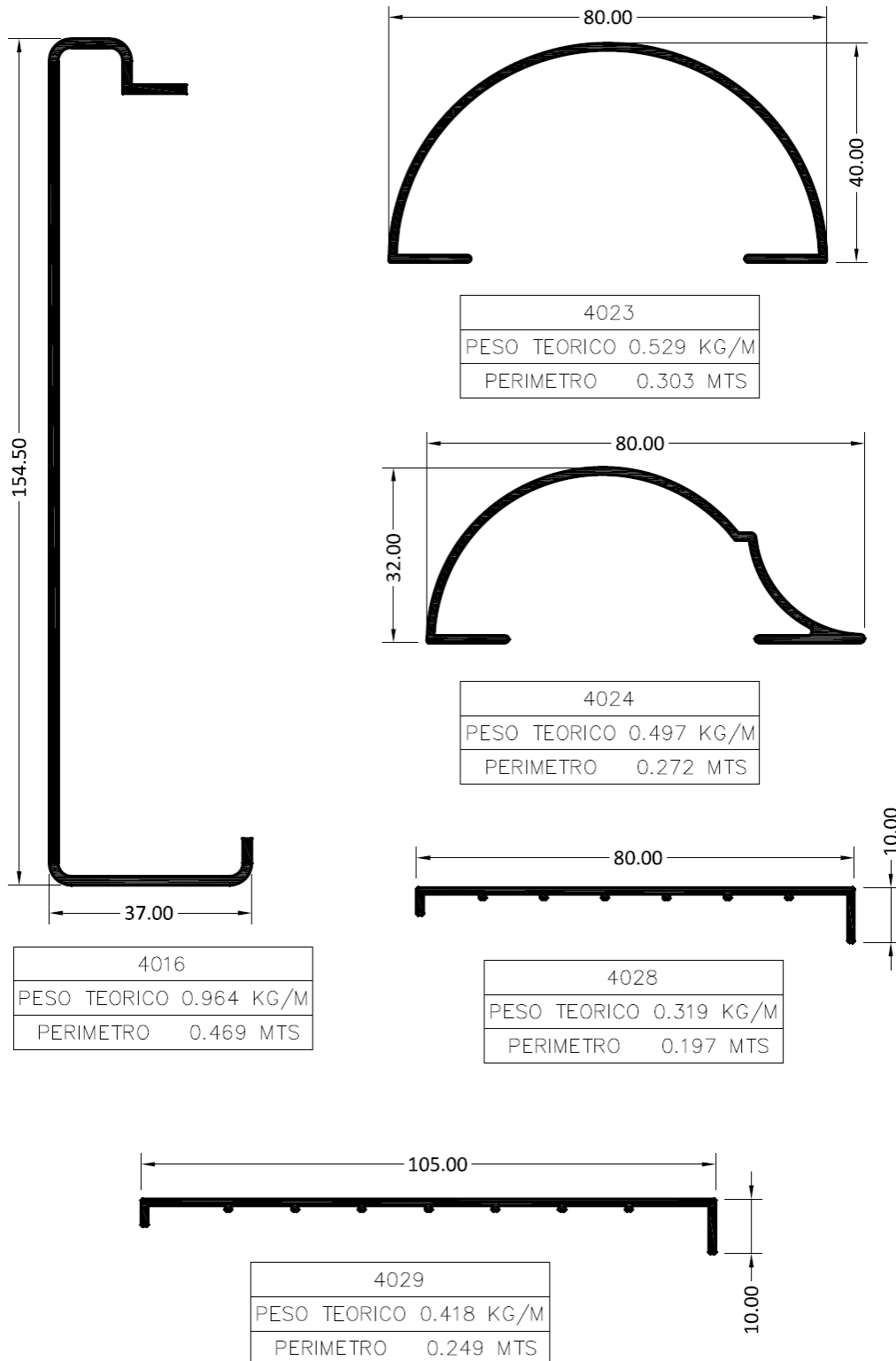



## LIBRE DISPOSICION

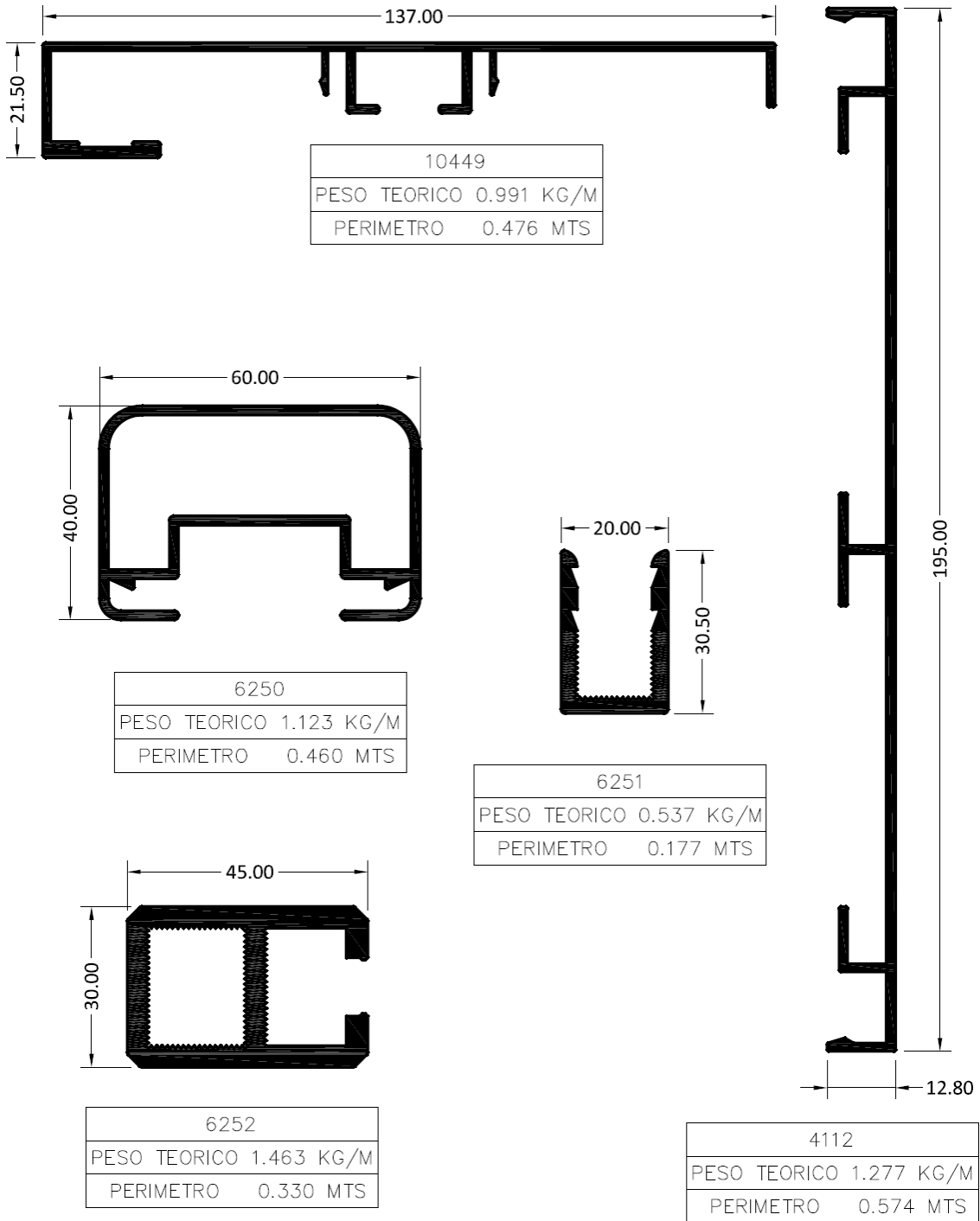



## LIBRE DISPOSICION

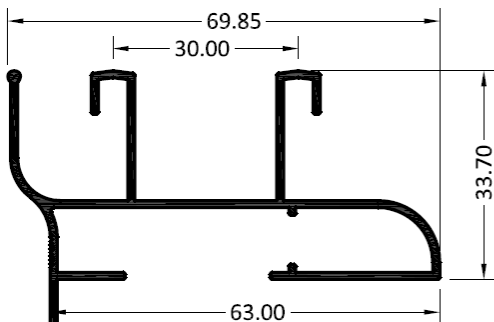

|                         |
|-------------------------|
| 10499                   |
| PESO TEORICO 0.705 KG/M |
| PERIMETRO 0.475 MTS     |

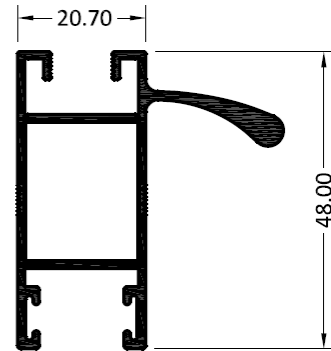

|                         |
|-------------------------|
| 10500                   |
| PESO TEORICO 0.678 KG/M |
| PERIMETRO 0.375 MTS     |

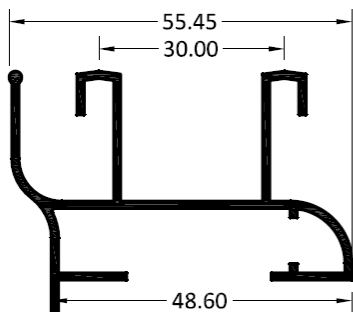

|                         |
|-------------------------|
| 10200                   |
| PESO TEORICO 0.624 KG/M |
| PERIMETRO 0.418 MTS     |

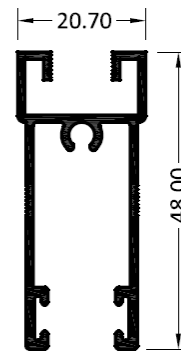

|                         |
|-------------------------|
| 10199                   |
| PESO TEORICO 0.486 KG/M |
| PERIMETRO 0.307 MTS     |

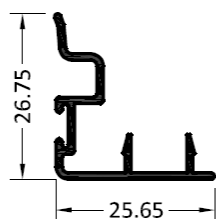

|                         |
|-------------------------|
| 10201                   |
| PESO TEORICO 0.213 KG/M |
| PERIMETRO 0.157 MTS     |

# iberalc



Iberalc, S.L. P.I. El Sequero Nº 177 – Arrúbal – La Rioja – España – Tlf 941205100 Fax 941222400  
[info@iberalc.com](mailto:info@iberalc.com) – [www.iberalc.com](http://www.iberalc.com)

LIBRE DISPOSICION

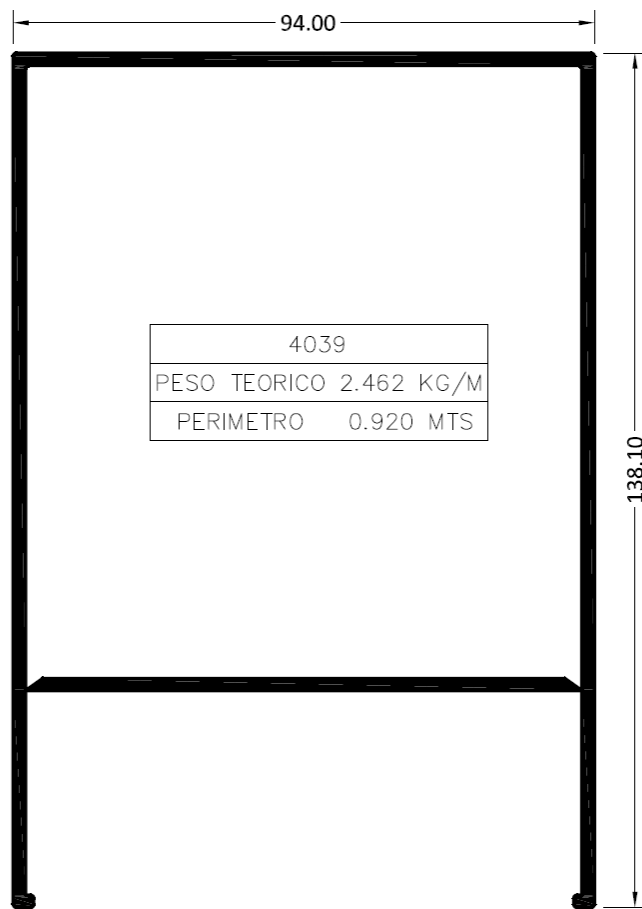



## LIBRE DISPOSICION

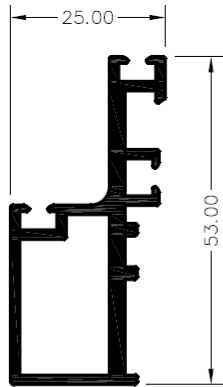

|                         |
|-------------------------|
| 10338                   |
| PESO TEORICO 0.748 KG/M |
| PERIMETRO 0.302 MTS     |

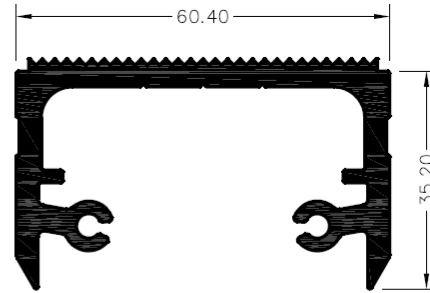

|                         |
|-------------------------|
| 10364                   |
| PESO TEORICO 1.577 KG/M |
| PERIMETRO 0.363 MTS     |

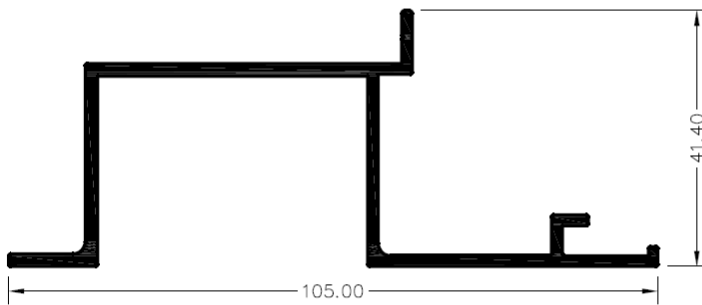

|                         |
|-------------------------|
| 10405                   |
| PESO TEORICO 0.962 KG/M |
| PERIMETRO 0.387 MTS     |

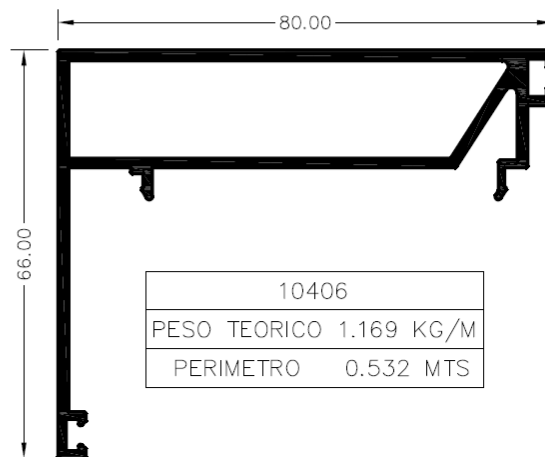

|                         |
|-------------------------|
| 10406                   |
| PESO TEORICO 1.169 KG/M |
| PERIMETRO 0.532 MTS     |





## LIBRE DISPOSICION

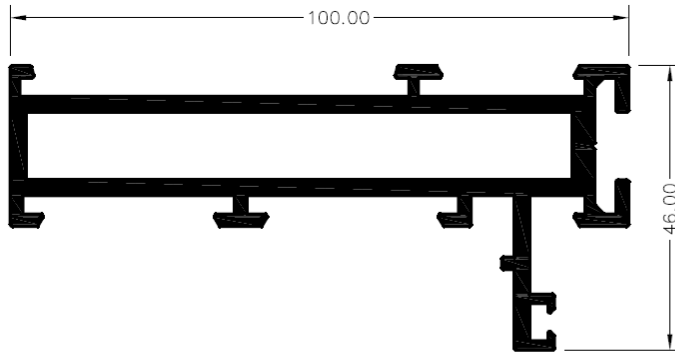

|                         |
|-------------------------|
| 10407                   |
| PESO TEORICO 2.076 KG/M |
| PERIMETRO 0.649 MTS     |

|                         |
|-------------------------|
| 10408                   |
| PESO TEORICO 0.859 KG/M |
| PERIMETRO 0.429 MTS     |

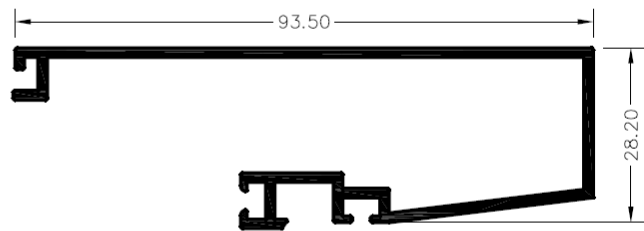

|                         |
|-------------------------|
| 10409                   |
| PESO TEORICO 1.185 KG/M |
| PERIMETRO 0.513 MTS     |

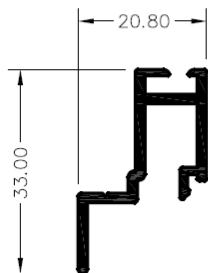
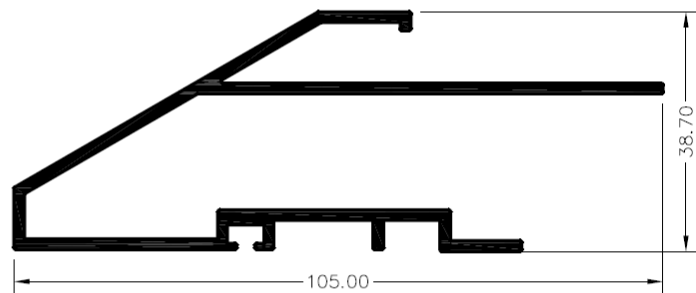

|                         |
|-------------------------|
| 10606                   |
| PESO TEORICO 0.310 KG/M |
| PERIMETRO 0.162 MTS     |

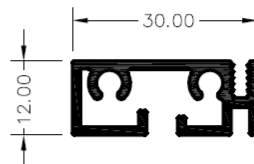

|                         |
|-------------------------|
| 10610                   |
| PESO TEORICO 0.373 KG/M |
| PERIMETRO 0.201 MTS     |



## LIBRE DISPOSICION

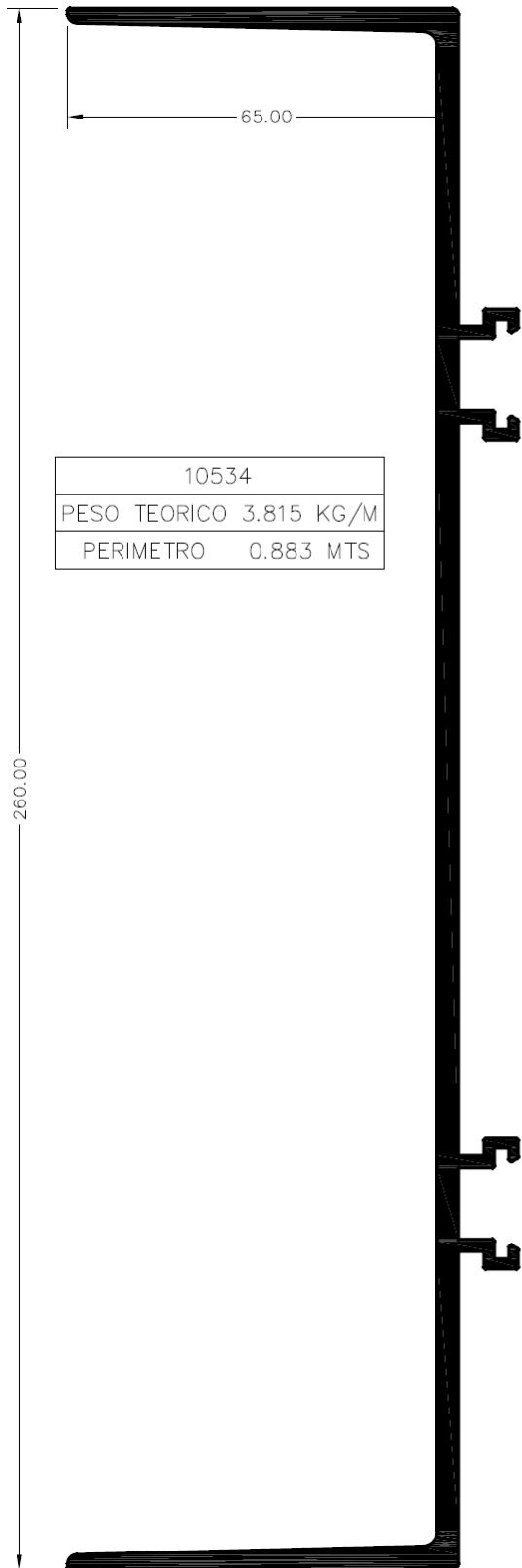

|                         |
|-------------------------|
| 10534                   |
| PESO TEORICO 3.815 KG/M |
| PERIMETRO 0.883 MTS     |

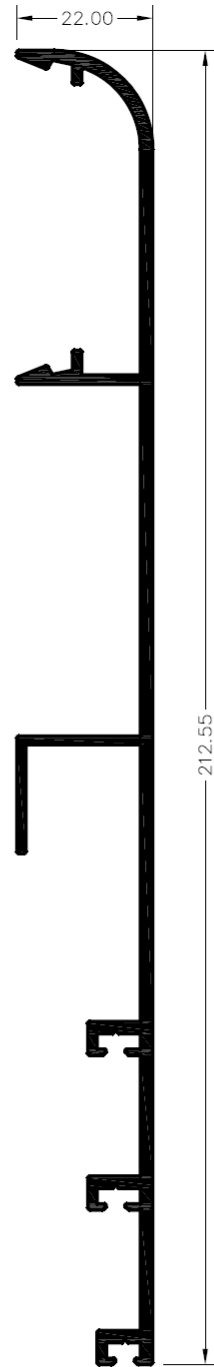

|                         |
|-------------------------|
| 10812                   |
| PESO TEORICO 1.686 KG/M |
| PERIMETRO 0.671 MTS     |



## LIBRE DISPOSICION

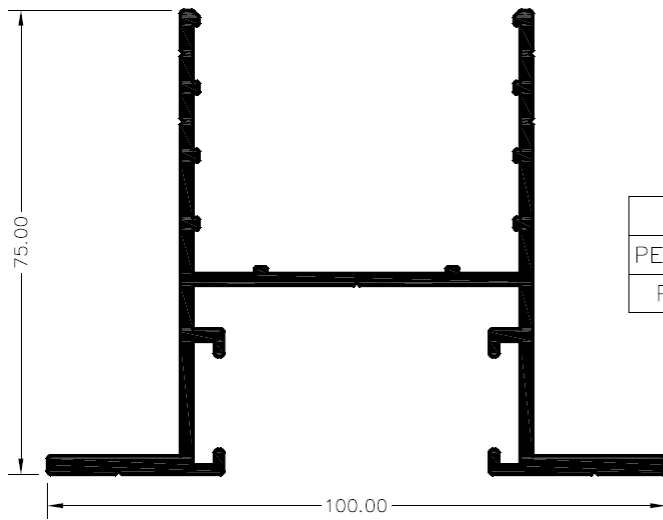

|                         |
|-------------------------|
| 10676                   |
| PESO TEORICO 1.625 KG/M |
| PERIMETRO 0.571 MTS     |

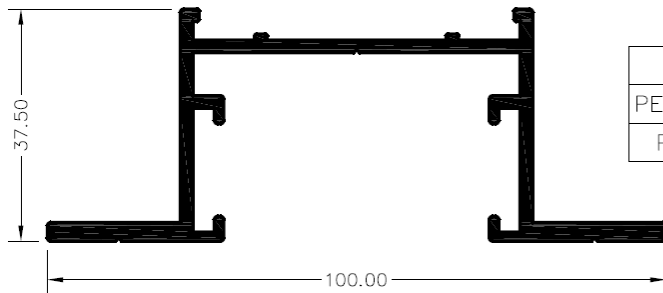

|                         |
|-------------------------|
| 10677                   |
| PESO TEORICO 1.191 KG/M |
| PERIMETRO 0.410 MTS     |

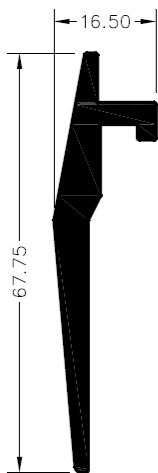

|                         |
|-------------------------|
| 10800                   |
| PESO TEORICO 0.861 KG/M |
| PERIMETRO 0.163 MTS     |

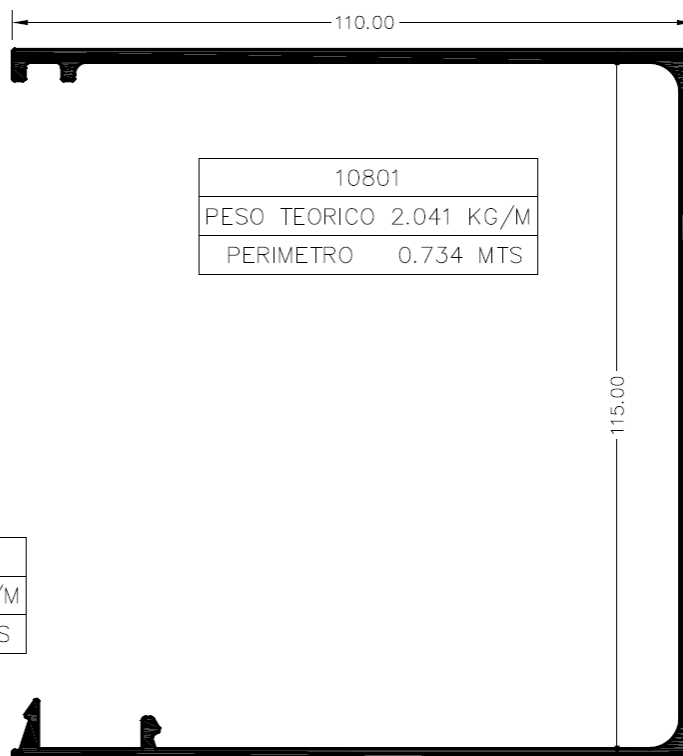

|                         |
|-------------------------|
| 10801                   |
| PESO TEORICO 2.041 KG/M |
| PERIMETRO 0.734 MTS     |



## LIBRE DISPOSICION

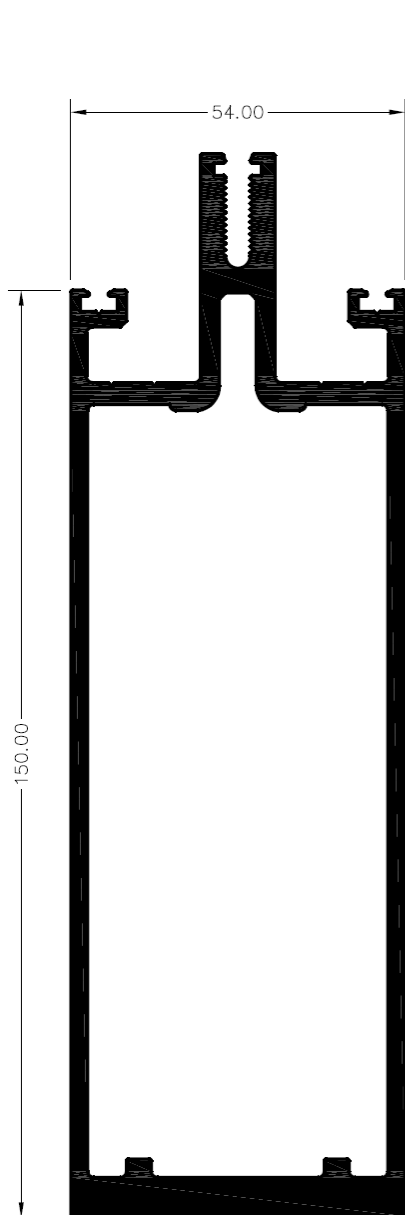

|              |            |
|--------------|------------|
| 10735        |            |
| PESO TEORICO | 4.361 KG/M |
| PERIMETRO    | 1.011 MTS  |

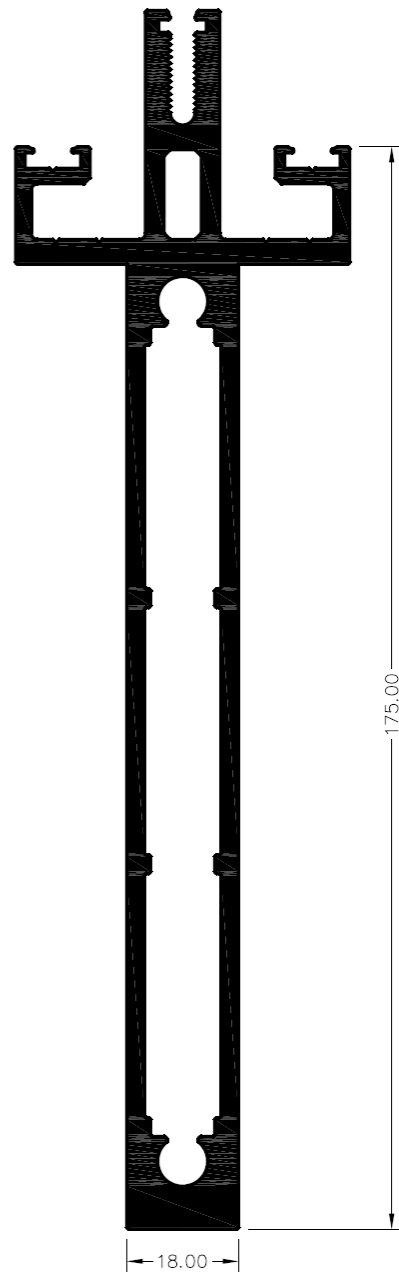

|              |            |
|--------------|------------|
| 10737        |            |
| PESO TEORICO | 4.644 KG/M |
| PERIMETRO    | 1.035 MTS  |

# iberalc



Iberalc, S.L. P.I. El Sequero Nº 177 – Arrúbal – La Rioja – España – Tlf 941205100 Fax 941222400  
[info@iberalc.com](mailto:info@iberalc.com) – [www.iberalc.com](http://www.iberalc.com)

## LIBRE DISPOSICION

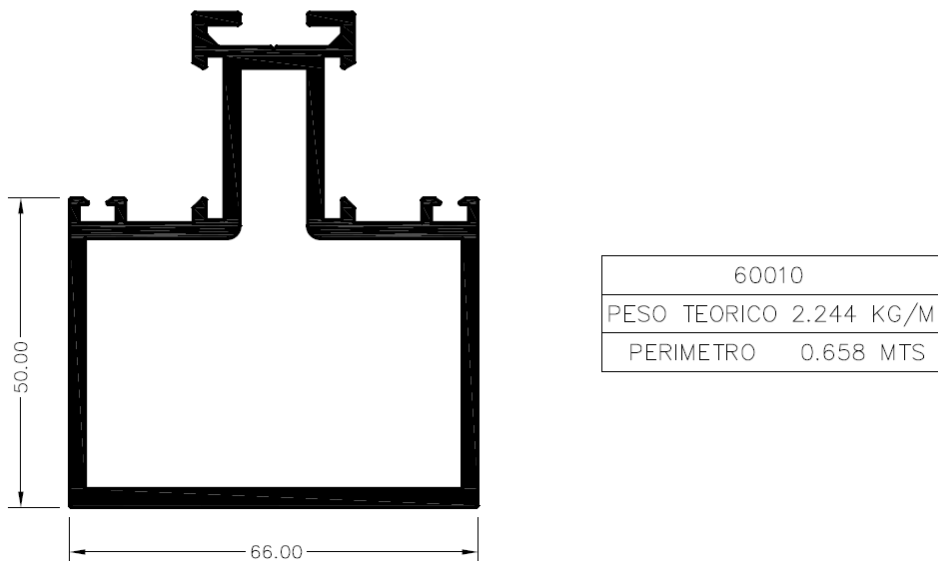
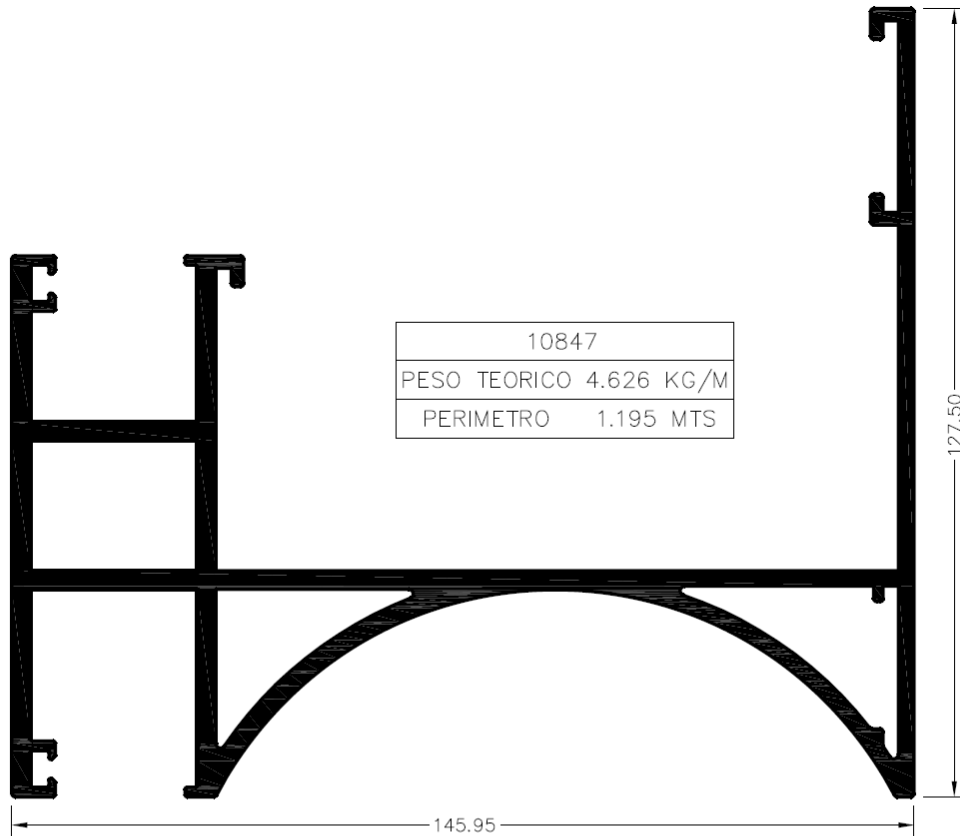



## LIBRE DISPOSICION

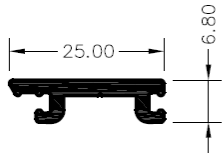

|              |            |
|--------------|------------|
| 60150        |            |
| PESO TEORICO | 0.221 KG/M |
| PERIMETRO    | 0.081 MTS  |

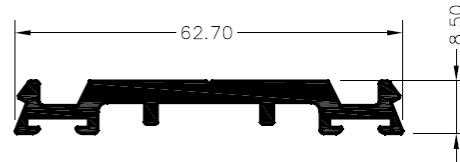

|              |            |
|--------------|------------|
| 60200        |            |
| PESO TEORICO | 0.672 KG/M |
| PERIMETRO    | 0.199 MTS  |

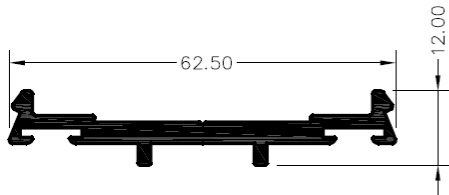

|              |            |
|--------------|------------|
| 60205        |            |
| PESO TEORICO | 0.624 KG/M |
| PERIMETRO    | 0.187 MTS  |

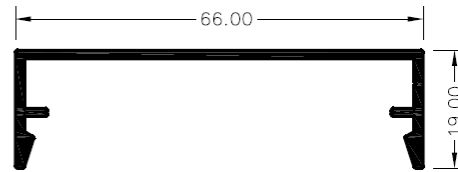

|              |            |
|--------------|------------|
| 60210        |            |
| PESO TEORICO | 0.421 KG/M |
| PERIMETRO    | 0.221 MTS  |

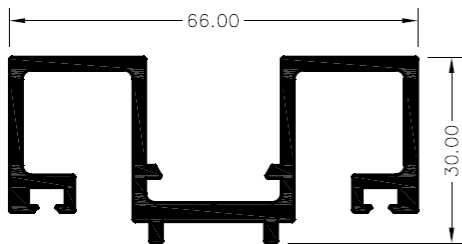

|              |            |
|--------------|------------|
| 60211        |            |
| PESO TEORICO | 1.158 KG/M |
| PERIMETRO    | 0.399 MTS  |

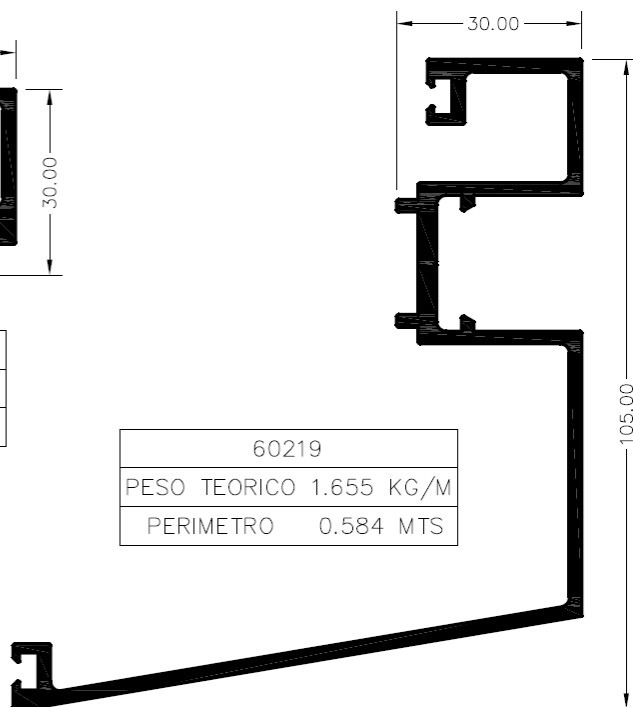

|              |            |
|--------------|------------|
| 60219        |            |
| PESO TEORICO | 1.655 KG/M |
| PERIMETRO    | 0.584 MTS  |



## LIBRE DISPOSICION

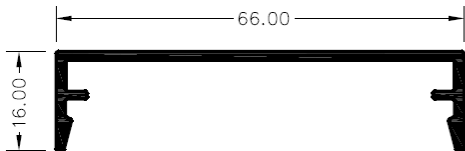

|                         |
|-------------------------|
| 60220                   |
| PESO TEORICO 0.386 KG/M |
| PERIMETRO 0.206 MTS     |

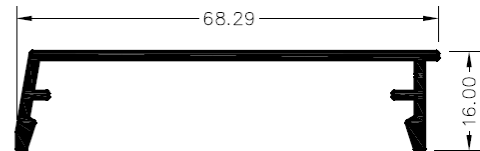

|                         |
|-------------------------|
| 60230                   |
| PESO TEORICO 0.393 KG/M |
| PERIMETRO 0.207 MTS     |

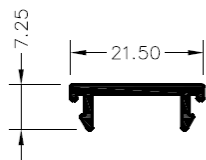

|                         |
|-------------------------|
| 60255                   |
| PESO TEORICO 0.132 KG/M |
| PERIMETRO 0.072 MTS     |

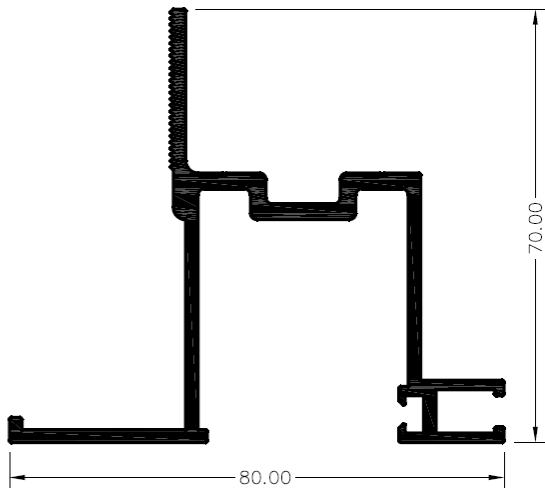

|                         |
|-------------------------|
| 60450                   |
| PESO TEORICO 1.284 KG/M |
| PERIMETRO 0.458 MTS     |

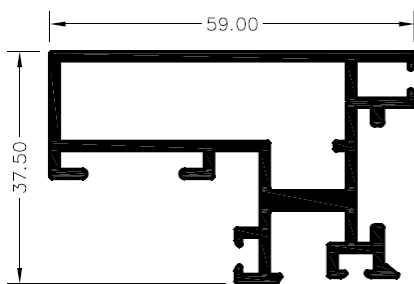

|                         |
|-------------------------|
| 60500                   |
| PESO TEORICO 1.029 KG/M |
| PERIMETRO 0.477 MTS     |

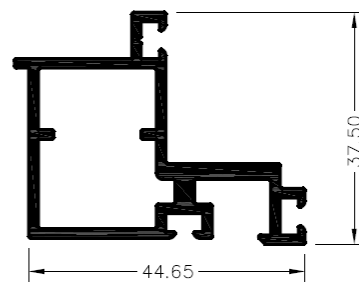

|                         |
|-------------------------|
| 60510                   |
| PESO TEORICO 0.756 KG/M |
| PERIMETRO 0.339 MTS     |



## LIBRE DISPOSICION

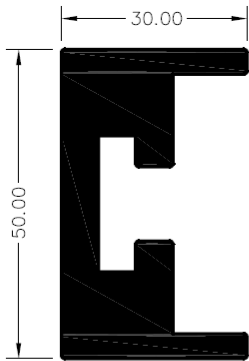

|              |            |
|--------------|------------|
| 5000         |            |
| PESO TEORICO | 2.137 KG/M |
| PERIMETRO    | 0.226 MTS  |

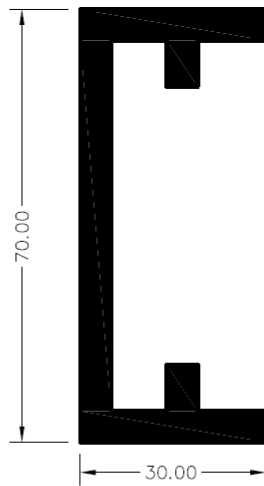

|              |            |
|--------------|------------|
| 5001         |            |
| PESO TEORICO | 1.822 KG/M |
| PERIMETRO    | 0.280 MTS  |

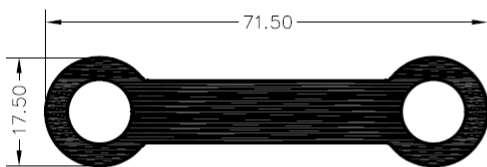

|              |            |
|--------------|------------|
| 10202        |            |
| PESO TEORICO | 1.844 KG/M |
| PERIMETRO    | 0.234 MTS  |

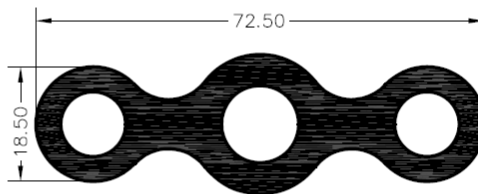

|              |            |
|--------------|------------|
| 10203        |            |
| PESO TEORICO | 2.074 KG/M |
| PERIMETRO    | 0.286 MTS  |

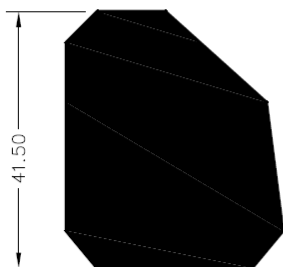

|              |            |
|--------------|------------|
| 10339        |            |
| PESO TEORICO | 3.300 KG/M |
| PERIMETRO    | 0.132 MTS  |

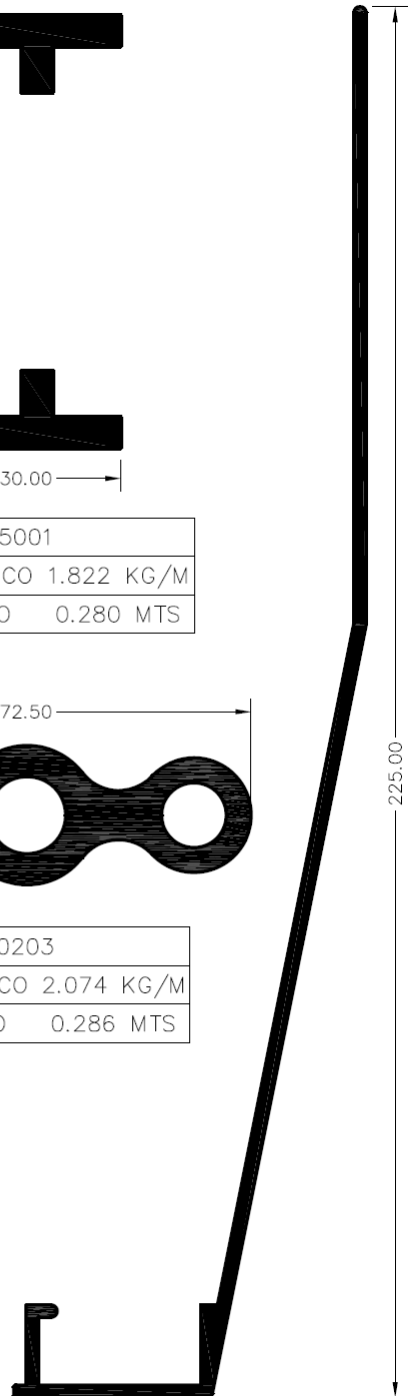

|              |            |
|--------------|------------|
| 10284        |            |
| PESO TEORICO | 1.523 KG/M |
| PERIMETRO    | 0.551 MTS  |



# iberalc



Iberalc, S.L. P.I. El Sequero Nº 177 – Arrúbal – La Rioja – España – Tlf 941205100 Fax 941222400  
[info@iberalc.com](mailto:info@iberalc.com) – [www.iberalc.com](http://www.iberalc.com)

## LIBRE DISPOSICION

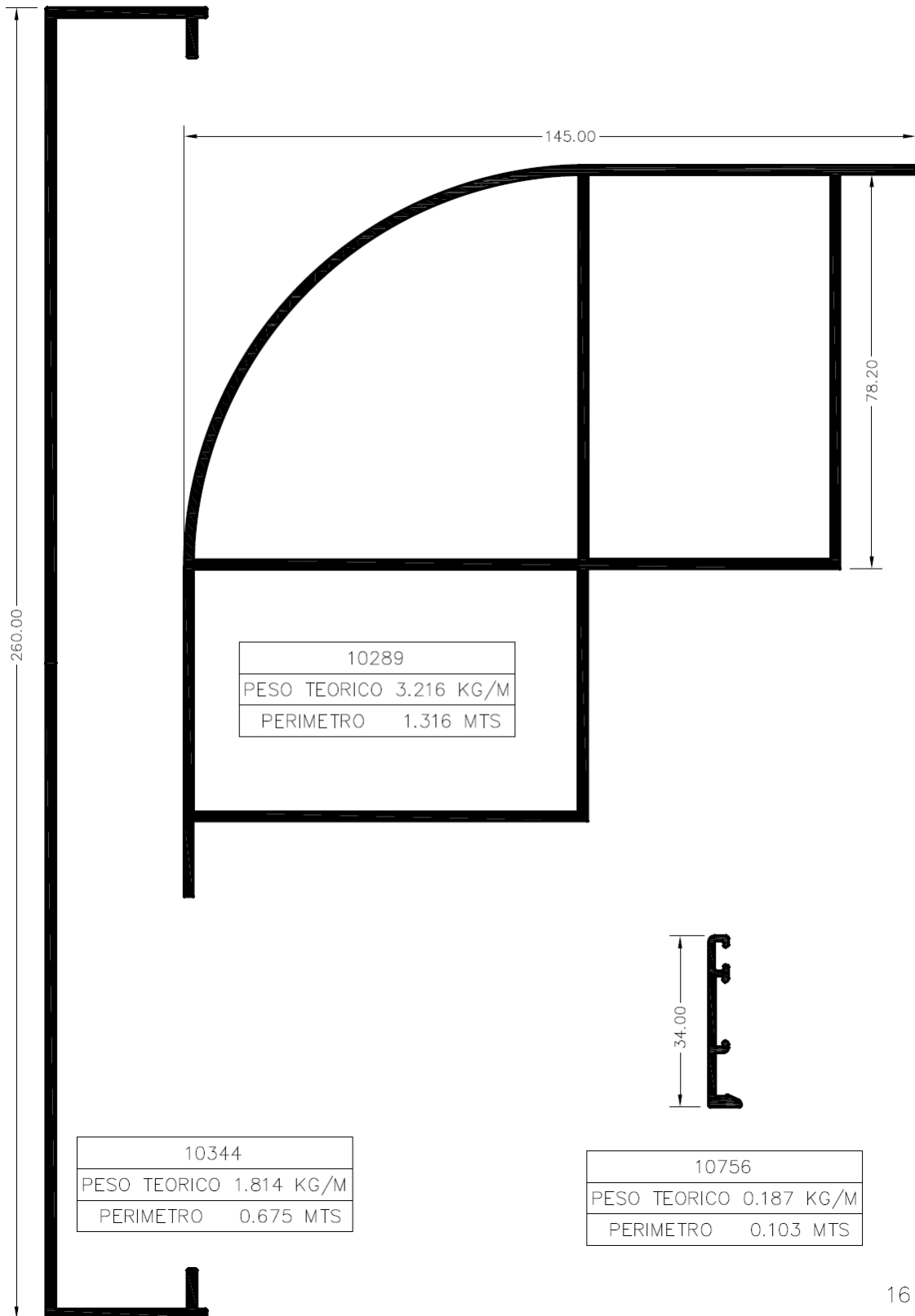



## LIBRE DISPOSICION

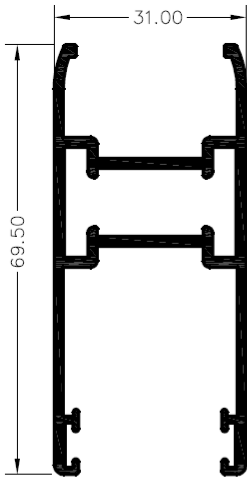

|                         |
|-------------------------|
| 10772                   |
| PESO TEORICO 0.923 KG/M |
| PERIMETRO 0.459 MTS     |

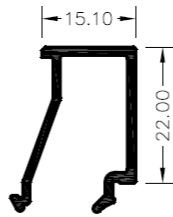

|                         |
|-------------------------|
| 10773                   |
| PESO TEORICO 0.244 KG/M |
| PERIMETRO 0.146 MTS     |

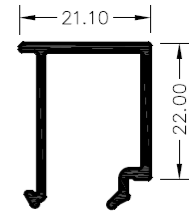

|                         |
|-------------------------|
| 10775                   |
| PESO TEORICO 0.261 KG/M |
| PERIMETRO 0.156 MTS     |

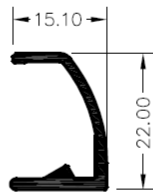

|                         |
|-------------------------|
| 10774                   |
| PESO TEORICO 0.195 KG/M |
| PERIMETRO 0.094 MTS     |

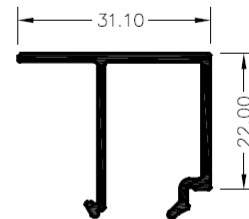

|                         |
|-------------------------|
| 10776                   |
| PESO TEORICO 0.297 KG/M |
| PERIMETRO 0.175 MTS     |

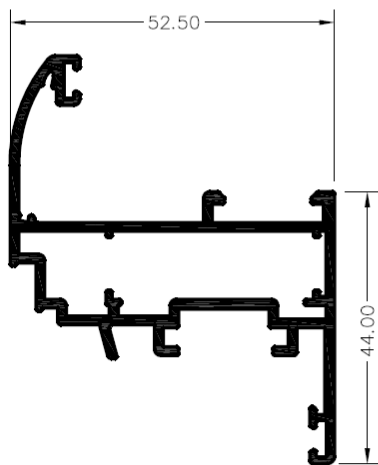

|                         |
|-------------------------|
| 10779                   |
| PESO TEORICO 0.985 KG/M |
| PERIMETRO 0.508 MTS     |

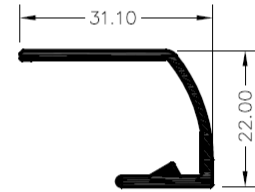

|                         |
|-------------------------|
| 10777                   |
| PESO TEORICO 0.251 KG/M |
| PERIMETRO 0.125 MTS     |

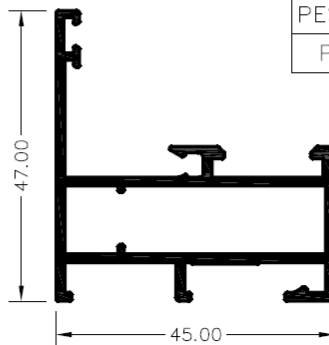

|                         |
|-------------------------|
| 10778                   |
| PESO TEORICO 0.742 KG/M |
| PERIMETRO 0.390 MTS     |



## LIBRE DISPOSICION

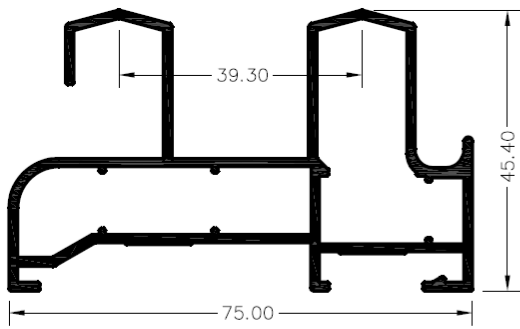

|                         |
|-------------------------|
| 10781                   |
| PESO TEORICO 1.173 KG/M |
| PERIMETRO 0.629 MTS     |

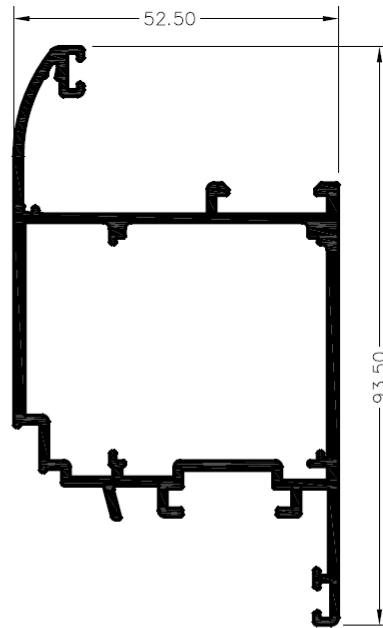

|                         |
|-------------------------|
| 10780                   |
| PESO TEORICO 1.331 KG/M |
| PERIMETRO 0.626 MTS     |

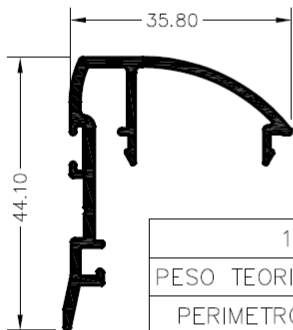

|                         |
|-------------------------|
| 10782                   |
| PESO TEORICO 0.451 KG/M |
| PERIMETRO 0.239 MTS     |

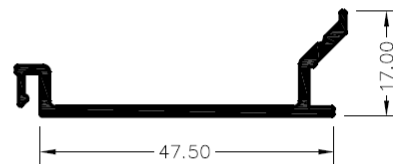

|                         |
|-------------------------|
| 10784                   |
| PESO TEORICO 0.328 KG/M |
| PERIMETRO 0.164 MTS     |

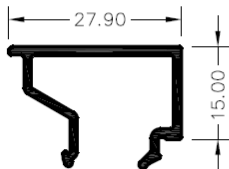

|                         |
|-------------------------|
| 10788                   |
| PESO TEORICO 0.249 KG/M |
| PERIMETRO 0.148 MTS     |

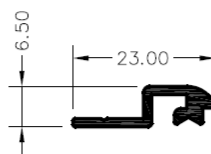

|                         |
|-------------------------|
| 10795                   |
| PESO TEORICO 0.140 KG/M |
| PERIMETRO 0.070 MTS     |



## LIBRE DISPOSICION

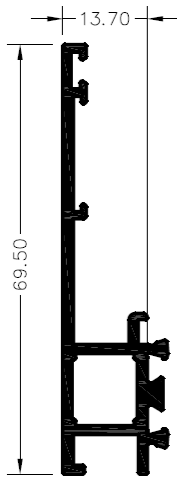

|                         |
|-------------------------|
| 10789                   |
| PESO TEORICO 0.613 KG/M |
| PERIMETRO 0.283 MTS     |

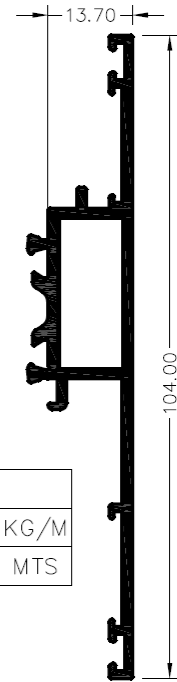

|                         |
|-------------------------|
| 10793                   |
| PESO TEORICO 0.825 KG/M |
| PERIMETRO 0.389 MTS     |

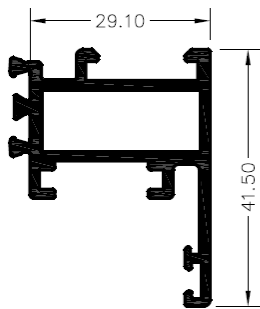

|                         |
|-------------------------|
| 10790                   |
| PESO TEORICO 0.676 KG/M |
| PERIMETRO 0.305 MTS     |

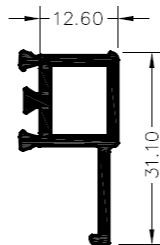

|                         |
|-------------------------|
| 10791                   |
| PESO TEORICO 0.329 KG/M |
| PERIMETRO 0.154 MTS     |

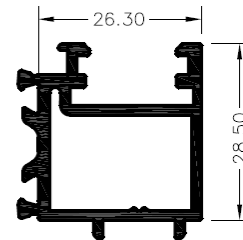

|                         |
|-------------------------|
| 10792                   |
| PESO TEORICO 0.605 KG/M |
| PERIMETRO 0.270 MTS     |

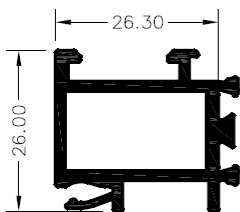

|                         |
|-------------------------|
| 10794                   |
| PESO TEORICO 0.540 KG/M |
| PERIMETRO 0.245 MTS     |

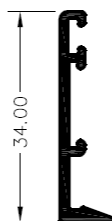

|                         |
|-------------------------|
| 10809                   |
| PESO TEORICO 0.193 KG/M |
| PERIMETRO 0.107 MTS     |

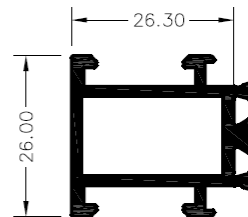

|                         |
|-------------------------|
| 10824                   |
| PESO TEORICO 0.531 KG/M |
| PERIMETRO 0.239 MTS     |



## LIBRE DISPOSICION

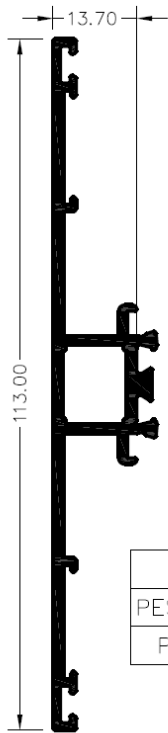

|                         |
|-------------------------|
| 10825                   |
| PESO TEORICO 0.832 KG/M |
| PERIMETRO 0.390 MTS     |

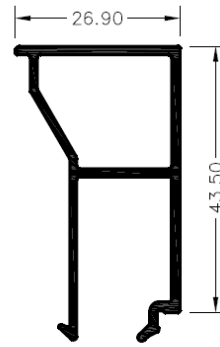

|                         |
|-------------------------|
| 10826                   |
| PESO TEORICO 0.476 KG/M |
| PERIMETRO 0.285 MTS     |

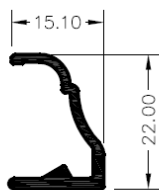

|                         |
|-------------------------|
| 10983                   |
| PESO TEORICO 0.193 KG/M |
| PERIMETRO 0.092 MTS     |

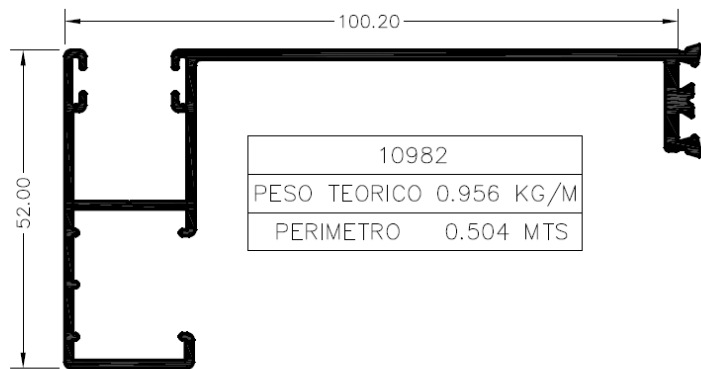

|                         |
|-------------------------|
| 10982                   |
| PESO TEORICO 0.956 KG/M |
| PERIMETRO 0.504 MTS     |

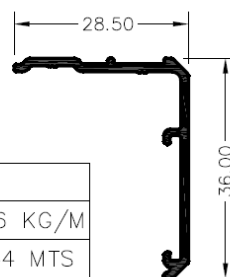

|                         |
|-------------------------|
| 10984                   |
| PESO TEORICO 0.236 KG/M |
| PERIMETRO 0.144 MTS     |