

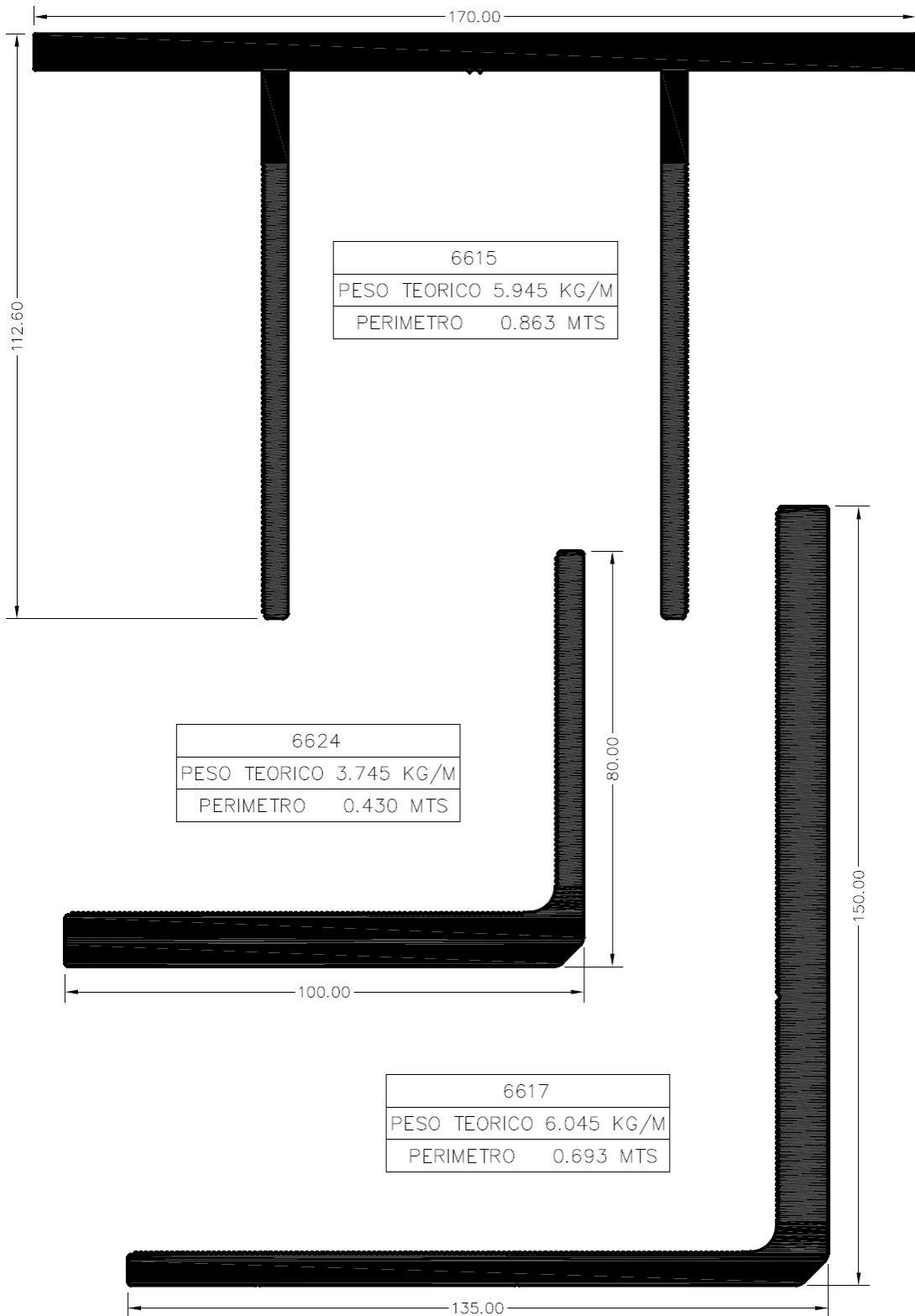

FACHADAS





FACHADAS

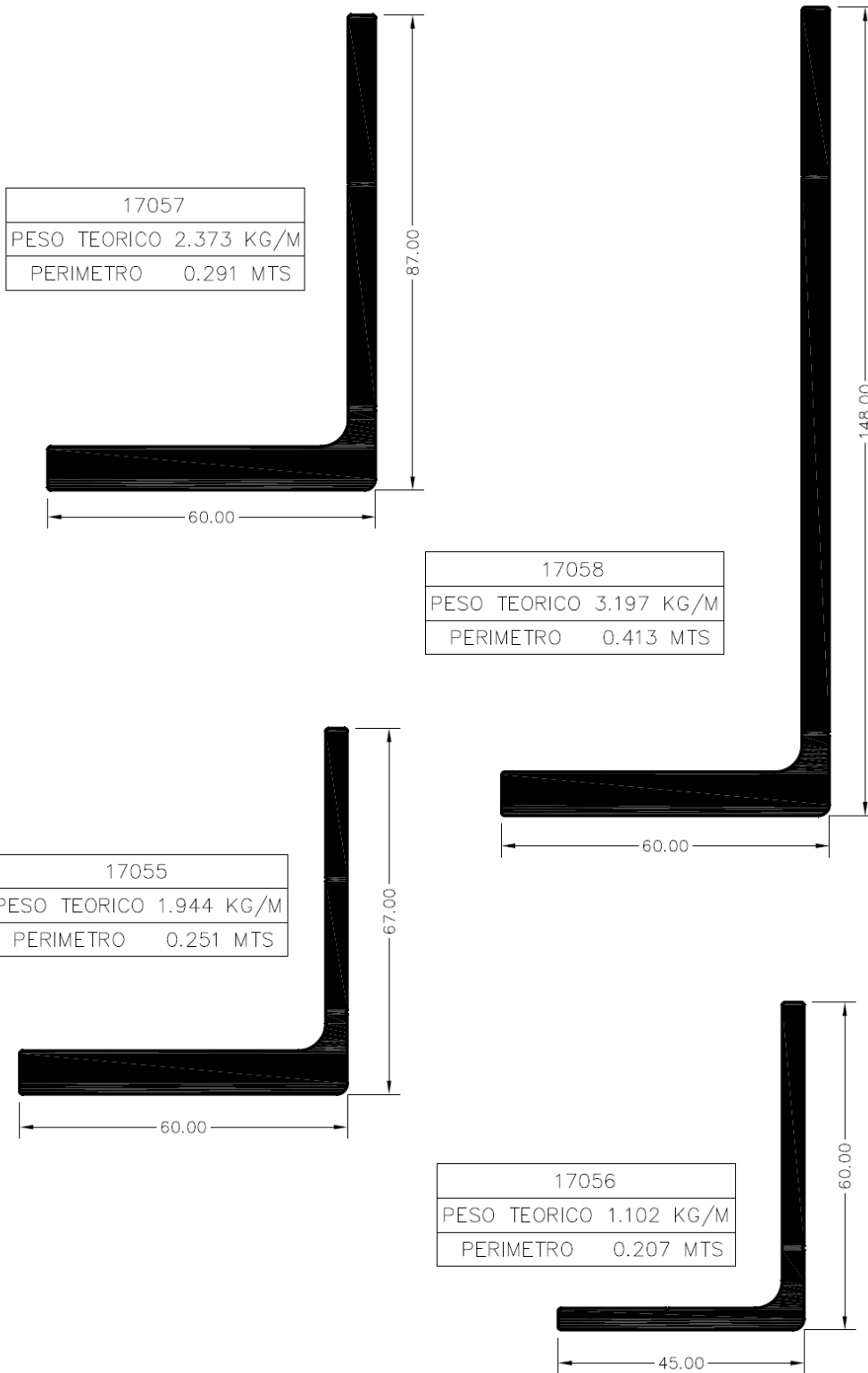



FACHADAS

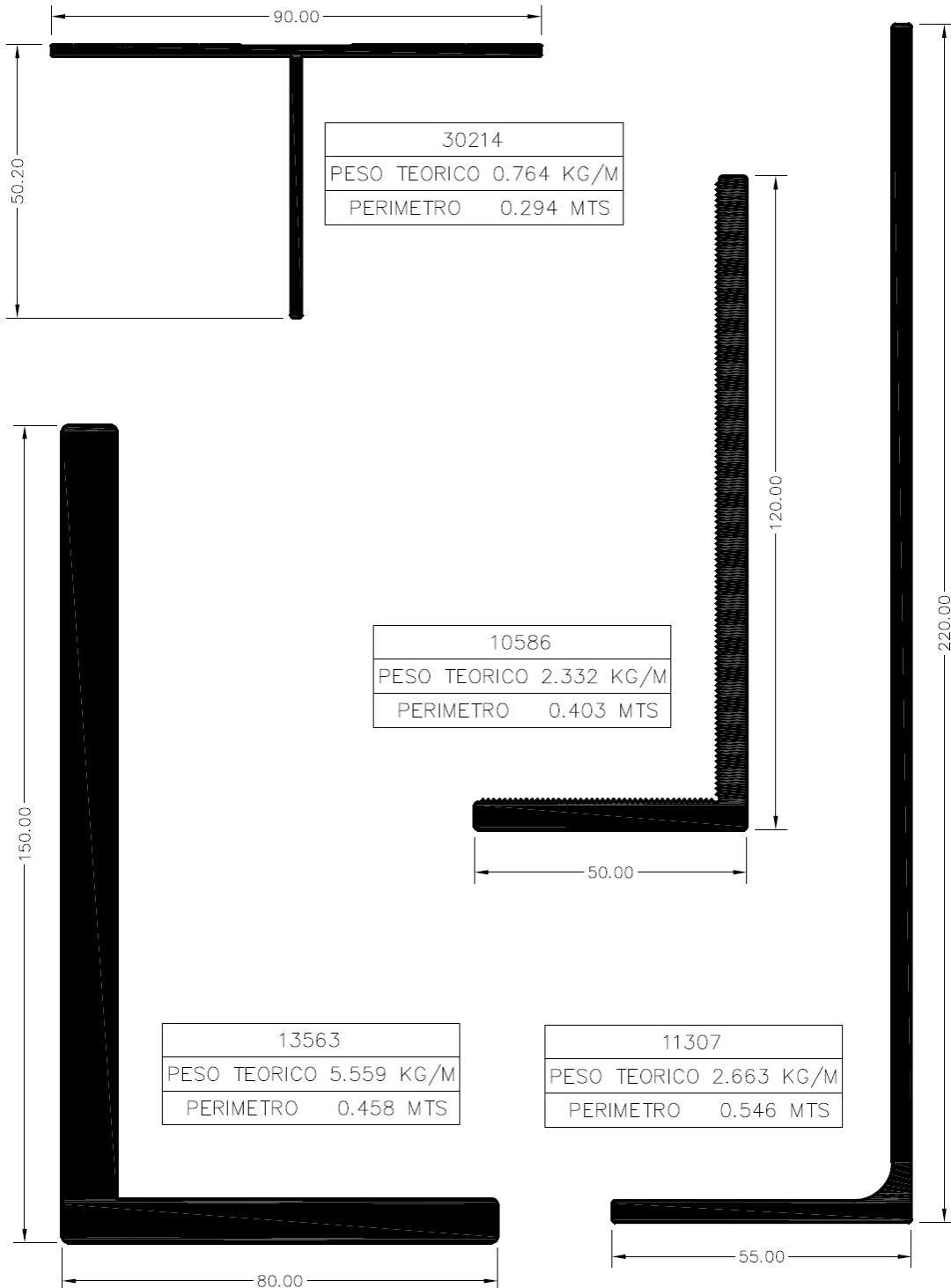



FACHADAS

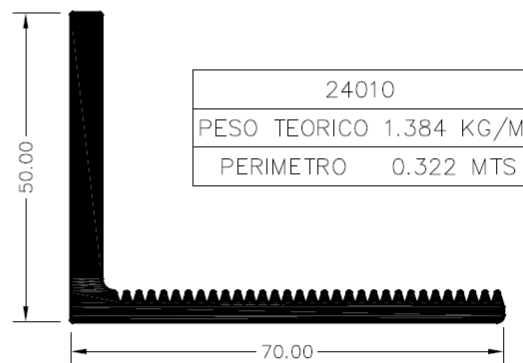



FACHADAS

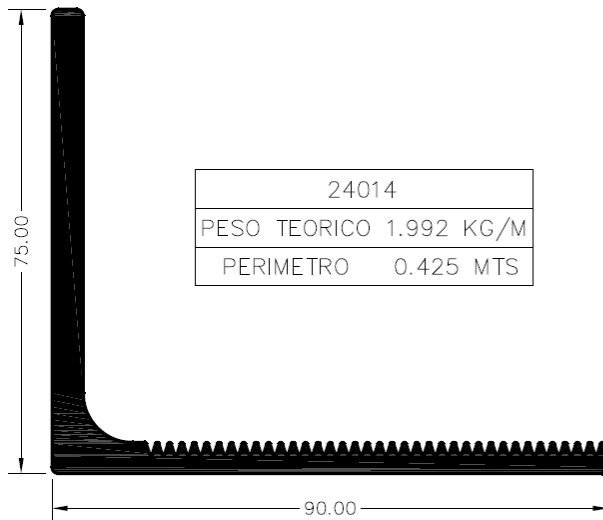
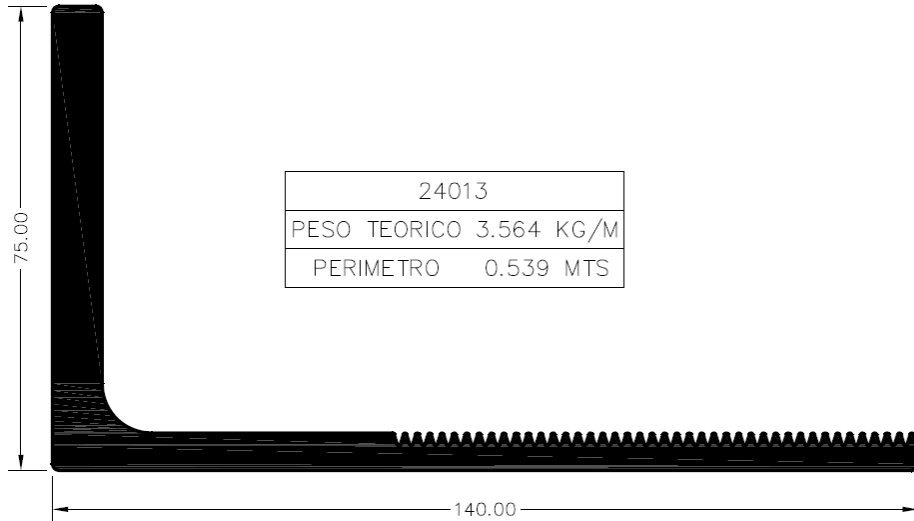

24015
PESO TEORICO 5.718 KG/M
PERIMETRO 0.639 MTS

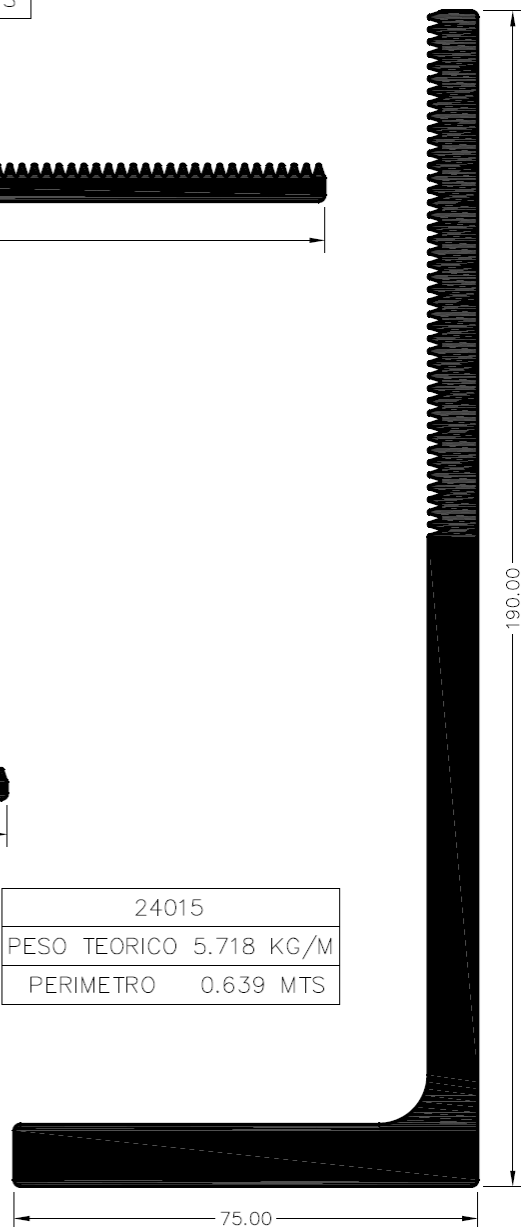



FACHADAS

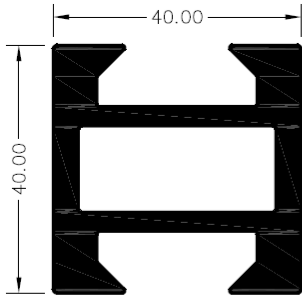

24000
PESO TEORICO 1.841 KG/M
PERIMETRO 0.314 MTS

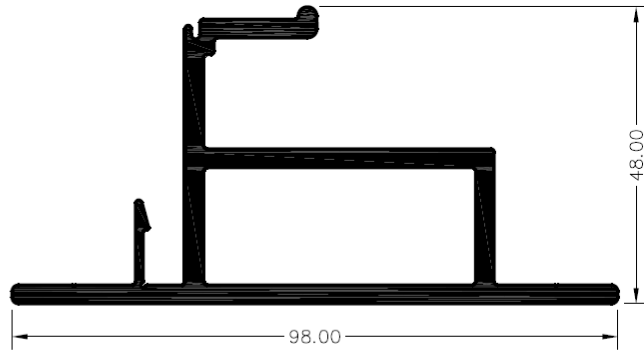

24001
PESO TEORICO 1.881 KG/M
PERIMETRO 0.480 MTS

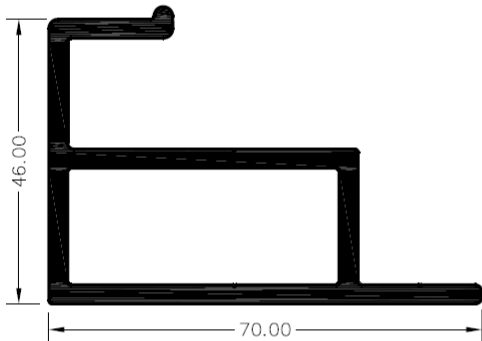

24002
PESO TEORICO 1.598 KG/M
PERIMETRO 0.390 MTS

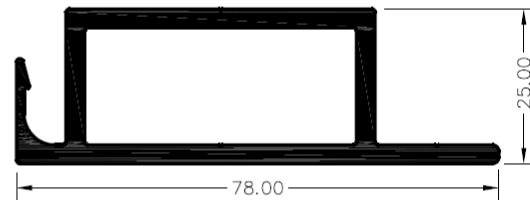

24003
PESO TEORICO 1.407 KG/M
PERIMETRO 0.357 MTS

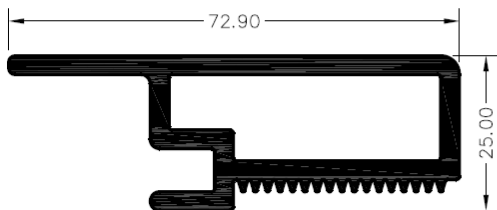

24004
PESO TEORICO 1.431 KG/M
PERIMETRO 0.372 MTS

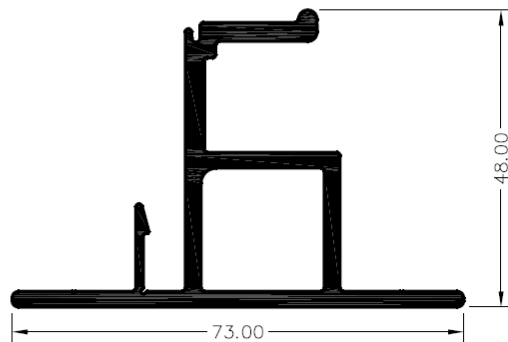

24005
PESO TEORICO 1.312 KG/M
PERIMETRO 0.384 MTS



FACHADAS

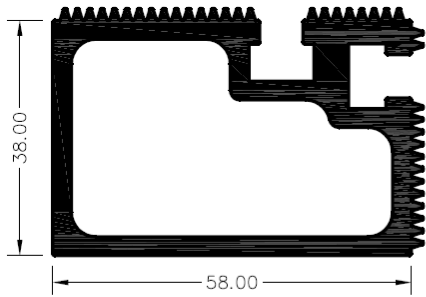

24006	
PESO TEORICO	2.042 KG/M
PERIMETRO	0.505 MTS

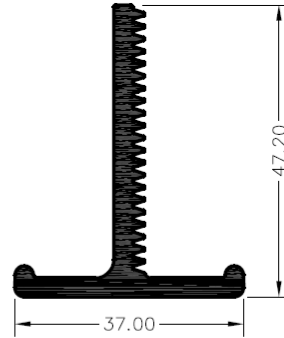

24007	
PESO TEORICO	0.808 KG/M
PERIMETRO	0.227 MTS

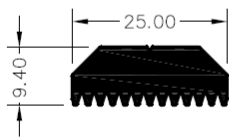

24008	
PESO TEORICO	0.513 KG/M
PERIMETRO	0.096 MTS

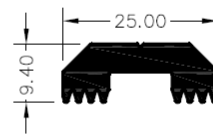

24018	
PESO TEORICO	0.402 KG/M
PERIMETRO	0.088 MTS

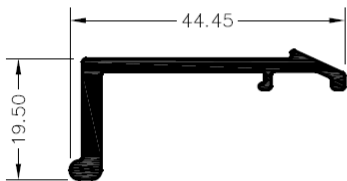

24016	
PESO TEORICO	0.402 KG/M
PERIMETRO	0.136 MTS

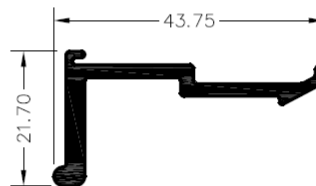

24017	
PESO TEORICO	0.416 KG/M
PERIMETRO	0.141 MTS

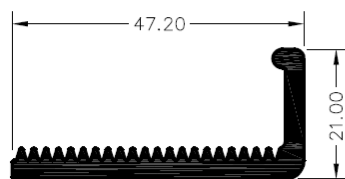

24022	
PESO TEORICO	0.656 KG/M
PERIMETRO	0.193 MTS

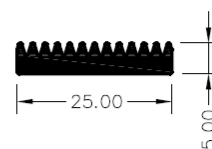

24023	
PESO TEORICO	0.272 KG/M
PERIMETRO	0.092 MTS



FACHADAS

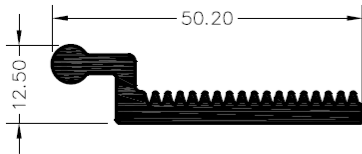

24019	
PESO TEORICO	0.601 KG/M
PERIMETRO	0.168 MTS

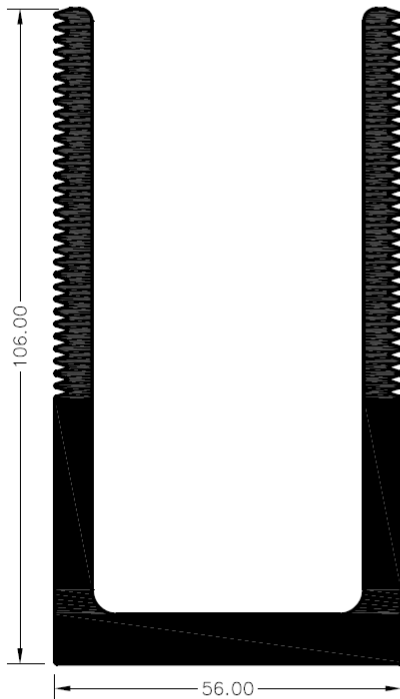

24021	
PESO TEORICO	4.058 KG/M
PERIMETRO	0.682 MTS

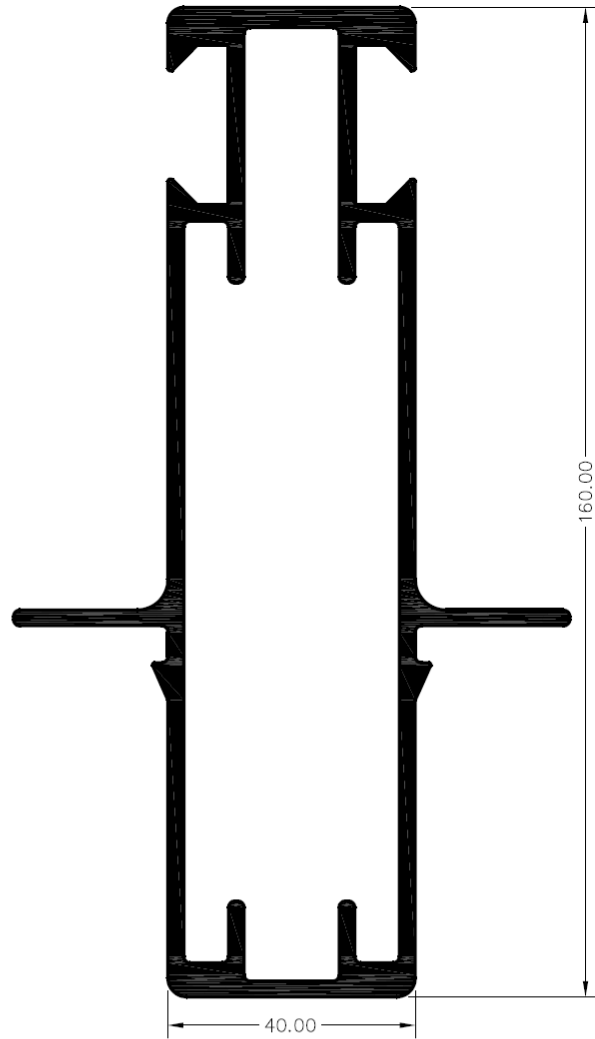

24020	
PESO TEORICO	3.963 KG/M
PERIMETRO	1.005 MTS